

# *Neuro/Spine and Orthopedic Instruments*

*Hooks, Micro Scissors, Rhoton-Merz Retractor  
Set and Spetzler Headrest System*



**RANEY Scalp Clip Applying Forceps**  
 Opens and holds each RANEY clip for quick application.

◆ (KO1169)

Overall length  
 6-1/4in (15.9cm).



**ADSON Drill Guide and Dura Protector**

(KO1170)

Overall length  
 6in (15.2cm).



**RANEY Scalp Hemostasis Clips**  
 Self-clamping spring steel clips. Mirror finish.



(KO1171)

**HUDSON Brace**  
 Standard pattern, for use with burs and drills.  
 Mirror and Satin finish.

(KO1172)



**HUDSON Bur**

(KO1173)

Diameter 11mm.



**ADSON Perforating Bur**  
 Four square-faced blades.  
 Speed cutting, holds sharpness well.

(KO1174)

Diameter 14mm.



**McKENZIE Perforating Twist Drill**

(KO1175)

Diameter 13mm.



**HUDSON Bur Oblong.**

(KO1176)

Diameter 14mm.



**McKENZIE Enlarging Bur**

◆ (KO1178)

Diameter 16mm.



DeVILBISS Cranial  
Rongeur Forceps  
With one extra blade.  
Overall length  
8in (20.3cm).

KO1179



DAVIS Conductor  
For Gigli saw. Nickle Plated.

KO1180

Overall length  
8-1/4in (21cm).



BAILEY Conductor  
For Gigli saw.

KO1181

Overall length  
13in (33cm).



NEURO/SPINE  
AND ORTHOPEDIC

GIGLI Wire Saws  
Standard type. Loops on both ends.

KO1182

Overall length  
12in (30.5cm).

KO1183  
Overall length  
20in (50.8cm).



V. Mueller <sup>®</sup> GIGLI Saw  
Round. Spiral surgical blade of stainless steel. Machine formed cutting edge  
cuts smoothly and continuously in any direction. Looped ends are carefully  
formed to reduce catching.

KO1184

Overall length  
12in (30.5cm).

KO1185  
Overall length  
20in (50.8cm).



Handles for GIGLI Saws  
Solid T-grip handle provided with deep hook. Pair. Mirror finish.

KO1186



Handles for GIGLI Saws  
Loop type. 3cm x 9cm wide. 3mm wire. Pair. Mirror finish.



Chroma-Line™ Taka™ Skull Base Curettes  
Overall length 7in (18cm). Straight.

0

Size 00000

0

Size 000

0

Size 0

0

Size 2

Straight

Straight	10° Angle	45° Angle	80° Angle	Cup Size	Color
U-2001	U-2016	U-2031	U-2046	00000	Silver
U-2003	U-2018	U-2033	U-2048	000	Turquoise
U-2005	U-2020	KO1187	U-2050	0	Green
U-2007	U-2022	U-2037	U-2052	2	Blue

Axial

Straight Up	Angled 10° Up	Angled 45° Up	Angled 80° Up	Cup Size	Color
KO1188	U-2076	U-2091		00000	Silver
U-2063	U-2078	U-2093	U-2108	000	Turquoise
U-2065	U-2080	U-2095		0	Green
U-2067	U-2082	U-2097	U-2112	2	Blue

Axial

Straight Down	Angled 10° Down	Angled 45° Down	Angled 80° Down	Cup Size	Color
U-2121	U-2136	U-2151		00000	Silver
U-2123	U-2138	U-2153	U-2168	000	Turquoise
U-2125	U-2140	U-2155	U-2170	0	Green
U-2127	U-2142	U-2157	U-2172	2	Blue

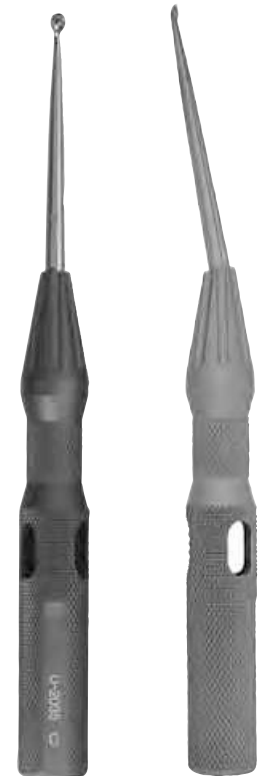

Straight

Axial



**DAVIS-Type Brain Retractors**  
Overall length  
7in (17.8cm).

- KO1189**  
1/4in (6mm) wide.
- KO1190**  
3/8in (10mm) wide.
- KO1191**  
1/2in (13mm) wide.
- KO1192**  
5/8in (16mm) wide.
- KO1193**  
1in (25mm) wide.



**DAVIS Brain Retractors**  
Flexible Silver.  
Overall length  
7-1/2in (19.1cm).

- KO1194**  
1/2in (1.3cm) wide.
- KO1195**  
5/8in (1.6cm) wide.
- KO1196**  
3/4in (1.9cm) wide.



**CHERRY S-Shaped**  
Brain Retractors  
Overall length  
6-3/4in (17.1cm).

- KO1197**  
10mm and 13mm wide.
- KO1198**  
16mm and 19mm wide.
- KO1199**  
22mm and 25mm wide.



**Silicone-Coated Brain Retractors**

Malleable. Round edges with extra silicone at the tip. Not recommended for use with lasers. Steam sterilization is recommended. Overall length 6-7/8in (17.5cm).

- ◆ **KO1200**  
Set of four. Includes small, medium, large and extra-large retractors.

Cat. No.	Description
NL1375-001	Small. Width tapers from 6mm to 10mm wide.
NL1375-002	Medium. Width tapers from 9mm to 15mm wide.
NL1375-003	Large. Width tapers from 11mm to 20mm wide.
NL1375-004	Extra-large. Width tapers from 14mm to 25mm wide.



**CUSHING Decompression Retractor**  
Angled. Fenestrated blade.

**KO1201**  
Overall length  
8-3/4in (22.2cm).



**SACHS Vein Retractors**  
Angled.

**KO1202**  
Toothed blade. Overall length  
9in (22.9cm).



**GIFFORD Retractor**  
3 x 3 blunt prongs.

**KO1203**  
Overall length  
3in (7.6cm).



**ALLPORT Retractor**  
4 x 4 blunt prongs.

**KO1204**  
Overall length  
2-5/8in (6.8cm).

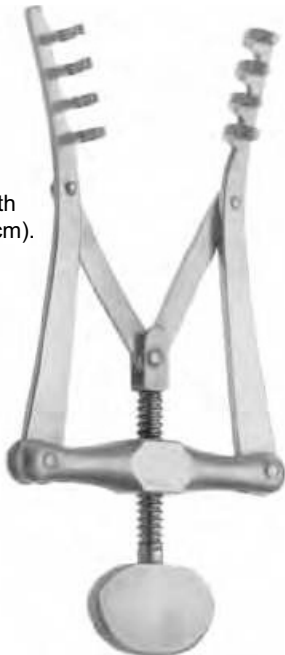

**JANSEN Retractor**  
3 x 3 blunt prongs.

**KO1205**  
Overall length  
4in (10cm).



**JANSEN Scalp Retractor**  
4 x 4 prongs. Total opening 3in (7.6cm).

**KO1206**  
Overall length  
4-5/8in (11.7cm).



Scalp Retractor  
3 x 4 sharp prongs. Total opening  
3-3/4in (9.5cm).

KO1207

Overall length  
5-1/8in (13cm).



ADSON Cerebellum Retractor  
4 x 4 prongs.

KO1208

Overall length  
7-1/2in (19cm).

KO1209  
Angled 45°. Overall length  
7-1/2in (19cm).

KO1210  
Angled 80°. Overall length  
7-1/2in (19cm).



D'ERRICO-ADSON Retractor  
Heavier than standard Adson, with angular shanks.

KO1211

Overall length  
7-3/8in (18.7cm).



MISKIMON Cerebellar Retractor  
7 sharp prongs per blade.  
Blade 1-3/8in deep x 1-1/4in  
(35mm x 32mm) wide.

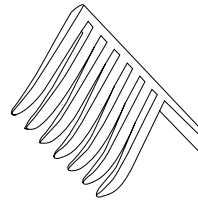

KO1212

Overall length  
8in (20.3cm).



**SPETZLER Headrest System Set**  
Set includes the following:

**KO1213**

- M-1500 Clamp. (1 each)
- M-1525 Base unit. (1 each)
- M-1570 Swivel adapter. (1 each)
- Flexible arms not included with the set.



**SPETZLER Skull Clamp**

**KO1214**



**SPETZLER Swivel Adapter**

**KO1215**



**SPETZLER Adjustable Base Unit**

**KO1216**



**SPETZLER Skull Pins Large.**

**KO1217**

- Disposable. Sterile.
- 3 pins per pack.
- 12 packs per case.



**SPETZLER Skull Pins Large. Stainless Steel with silicone o-ring.**

**KO1218**

- Reusable. Nonsterile.
- 1 pin per pack.

KO1219  
Disposable.  
Sterile. 3 pins per pack.  
12 packs per case.



**SPETZLER Skull Pins Small. Stainless Steel with silicone o-ring.**

**KO1220**

- Reusable.
- Nonsterile.
- 1 pin per pack.

KO1221  
Disposable. Sterile.  
3 pins per pack.  
12 packs per case.



GARDNER-WELLS Traction Tongs

◆ **KO1222**

Set includes the following:

- NL9501 Arch. (1 each)
- NL9502 Lock nuts. (2 each)
- NL9503 S-hook. (1 each)
- NL9504 Test bar. (1 each)
- NL9506 Spring-loaded fixation screws. (2 each)

GARDNER-WELLS Titanium Traction Tongs

Available in small, medium, and large openings. Set includes the following:

- Titanium Arch. (1 each)
- Titanium Lock nuts. (2 each)
- Titanium S-hook. (1 each)
- Titanium Test bar. (1 each)
- Titanium Spring-loaded fixation screws. (2 each)

KO1223  
Small.  
Opening  
7in (17.8cm).

KO1225  
Medium.  
Opening  
7-1/2in (19cm).

KO1224  
Large.  
Opening  
8in (20.3cm).

**titanium**

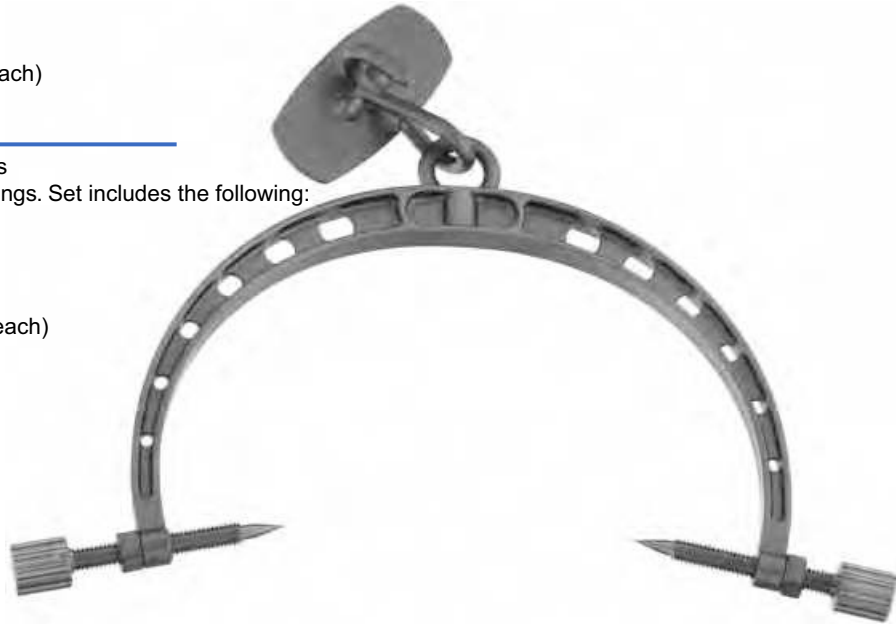

GARDNER-WELLS Traction Components

◆ **KO1226**

S-hook.

◆ **KO1227**

Test bar.

◆ **KO1228**

Titanium wrench.

KO1229  
Arch only.



NL9503



NL9504

GARDNER-WELLS Lock Nuts

◆ **KO1230**

Lock nuts.

KO1231  
Titanium. Lock nuts.



GARDNER-WELLS Fixation Screws

◆ **KO1232**

Fixation screw.  
Non-spring-loaded.

KO1233  
Fixation screw.  
Spring-loaded.

KO1234  
Titanium.  
Fixation screw.  
Spring-loaded.

KO1235  
Titanium.  
Fixation screw.  
Non-spring-loaded.





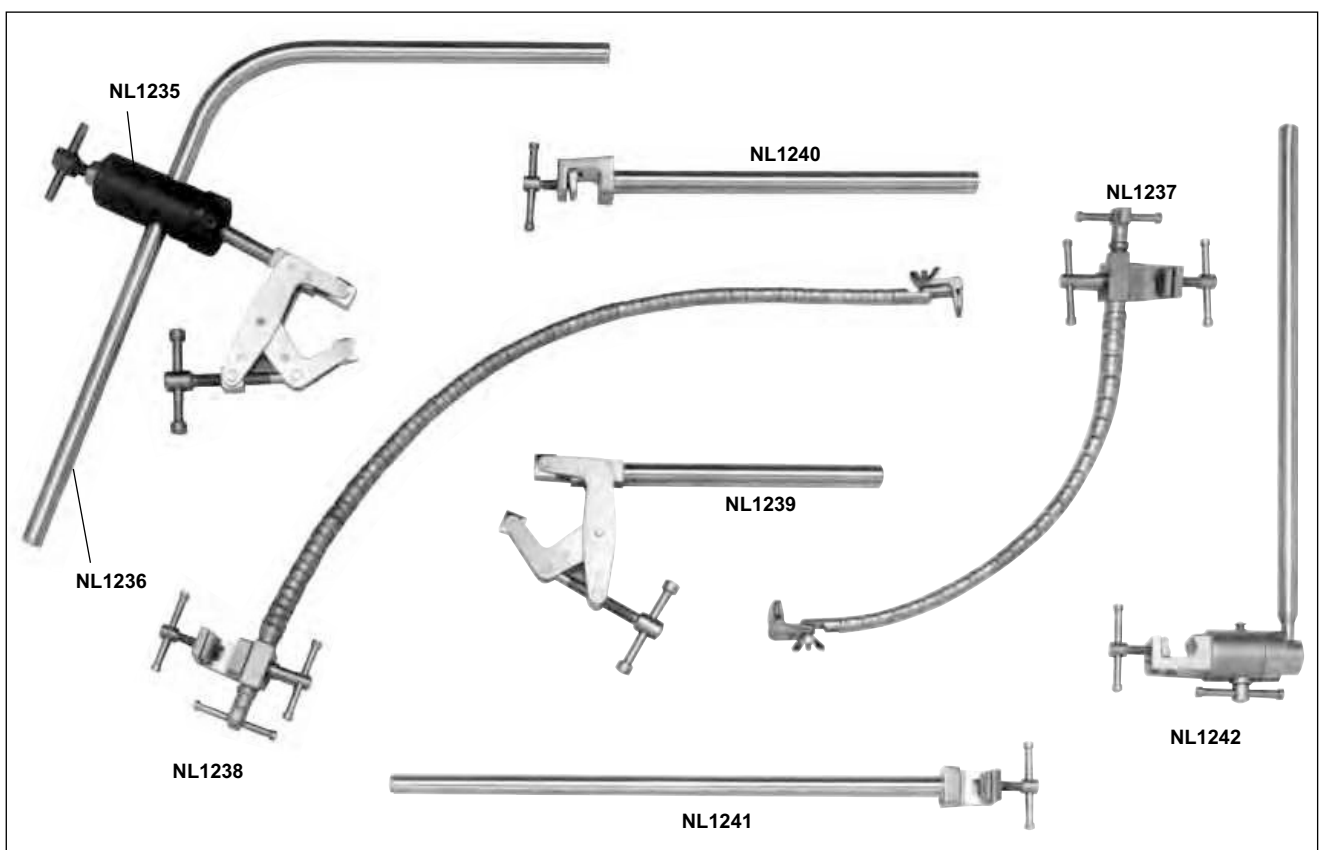

RHOTON-MERZ Brain Retractor Set

◆ **KO 1235**  
Complete set.

**KO 1236**  
Ball and Socket unit with opening to accommodate 1/2in (13mm) diameter round tubing. Clamping device to fasten to SPETZLER Head Holder.

**KO 1237**  
Holding bar, rigid, curved, 1/2in (13mm) diameter round tubing. Wall thickness 2mm, long solid plug on each end. Overall length 21in (53.3cm).

**KO 1238**  
Flexible arm for self-retaining retraction. Tapered. Length 30cm, with clamping device to fit 1/2in (13mm) round tubing.

**KO 1239**  
Flexible arm for self-retaining retraction. Tapered. Length 48cm, with clamping device to fit 1/2in (13mm) round tubing.

**KO 1240**  
Clamping unit with T-screw fitted with 1/2in (13mm) diameter round tubing. Attaches to the SPETZLER Pinion Head Holder.

**KO 1241**  
Clamping device fitted with 1/2in (13mm) diameter round tubing, 8in (20.3cm) long. Attaches to the clamping unit which attaches to the SPETZLER Head Holder.

**KO 1242**  
Clamping device fitted with 1/2in (13mm) diameter round tubing, 12in (30.5cm) long. Attaches to the clamping unit which attaches to the SPETZLER Head Holder.

**KO 1243**  
The clamping device will accommodate the 1/2in (13mm) diameter round tubing, 12in (30.5cm) long. Attaches to the clamping unit which attaches to the SPETZLER Head Holder.

**RHOTON Malleable Steel Retractors**  
With square end tips.

- ◆ **KO1244**  
Tips 6mm and 10mm wide. Center 5mm.  
Overall length 8-1/4in (21cm).
- ◆ **KO1245**  
Tips 10mm and 20mm wide. Ends taper from 20mm to 10mm and from 25mm to 20mm. Center 14mm.
- ◆ **KO1246**  
Tips 2mm and 3mm wide. Center 15mm.
- ◆ **KO1247**  
Tips 4mm and 6mm wide. Center 15mm.
- ◆ **KO1248**  
Tips 8mm and 12mm wide. Center 7mm.  
Overall length 8-1/4in (21cm).
- ◆ **KO1249**  
Tips 14mm and 18mm wide. Center 10mm.  
Overall length 8-1/4in (21cm).
- ◆ **KO1250**  
Tips 16mm and 20mm wide. Center 12mm.  
Overall length 8-1/4in (21cm).
- ◆ **KO1251**  
Tips 22mm and 26mm wide. Center 14mm.  
Overall length 8-1/4in (21cm).
- ◆ **KO1252**  
Tips 24mm and 28mm wide. Center 16mm.  
Overall length 8-1/4in (21cm).
- ◆ **KO1253**  
Tips 3mm and 5mm wide. Ends taper from 10mm to 3mm and from 15mm to 5mm.  
Center 10mm.
- ◆ **KO1254**  
Tips 5mm and 10mm wide. Ends taper from 10mm to 5mm and from 15mm to 10mm.  
Center 10mm.
- ◆ **KO1255**  
Tips 6mm and 15mm wide. Ends taper from 20mm to 6mm and from 20mm to 15mm.  
Center 14mm.

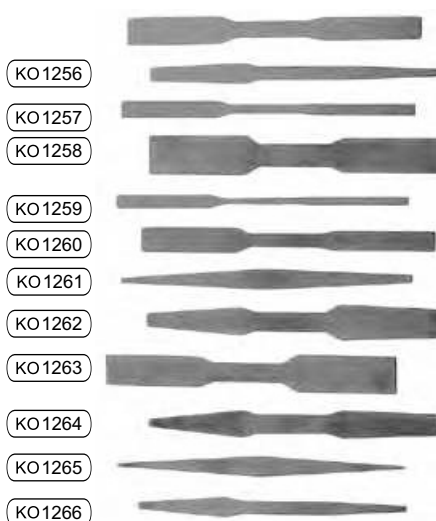

**WIET Flexible Arm**

The retractor system features a short, flexible arm that's easy to manage. Once adjusted into position, it is securely locked in place with a clamping device. The arm is designed to hold retractor blades such as the JANNETTA retractor blades or RHOTON-MERZ malleable retractor blades.

**KO1267**  
Overall length  
9-3/4in (24.8cm).

**KO1268**  
Clamping device only. Fits any self-retaining retractor with a 1/2in (13mm) maximum bar. Provides a post for mounting WIET Flexible Arm.



**LEYLA Self-Retaining Brain Retractor Set**

- KO1269**  
Includes the following:  
 KO1270 1 Fixation Base for two Flexible Arms  
 KO1271 2 Flexible Arms  
 KO1272 2 Supports for Flat Brain Spatulas

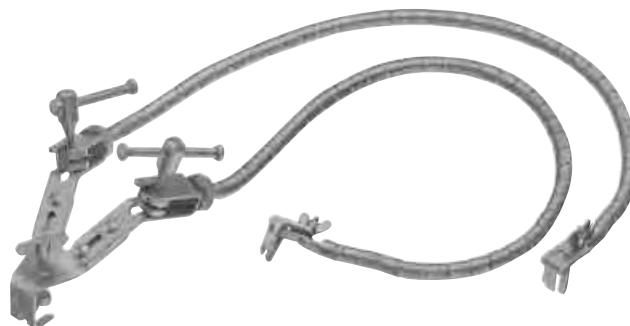

---

**Fixation Base**  
For mounting on two flexible arms.

KO1273



---

**LEYLA Flexible Arm**  
Flexible in all directions.

KO1274



---

**V. Mueller Instrument Warranty**

We warranty every medical device and accessory bearing the V. Mueller brand name to be free of functional defects in workmanship and materials when used normally for its intended use. Any V. Mueller product proving to be so defective will be replaced or repaired at no charge. Repairs or modifications performed by unauthorized personnel may void all product warranties and could affect performance and efficacy of the device.

---

**Support for Flat Brain Spatulas**  
For mounting on flexible arms.

KO1275



---

**Support**  
For round shaped instruments (suction tubes, light carriers, electrodes, etc.) with diameters up to 5.5mm.

KO1276



---

**Fixation Base**  
For mounting on one flexible arm.

KO1277



**Rigid Holding Rod**

Attaches to sliding rail (sizes up to 28mm) of operating tables.

KO1278



**Ball Joint Block**

For holding NL1279-002 rigid holding rod; attaches to sliding rail of operating tables. Sizes up to 1-1/8in (28mm). Holding rod not included.

KO1279



**RHOTON-MERZ Rotatable Coupling Head**

Improved construction with precisely meshing teeth to secure flexible arm(s). Coupling provides maximal flexibility in selecting a position for retractor by rotating 360° on holding bar and having a head which allows retractor arms to be rotated 360° on coupling. Once proper position is selected, it can be secured firmly in position. Can be used with components and accessories for LEYLA Retractor.

KO1280



**Coupling Head**

For fixing 1-5 flexible arms NL1275-002 for holding spatulas, suction tubes, illuminators, etc.

KO1281



**DAVIS Brain Spatulas**

Double-ended. Overall length 8in (20.3cm).

KO1282

Ends 10mm and 13mm wide.

KO1283

Ends 22mm and 25mm wide.



**CUSHING Brain Spatula**

Tapers from 25mm to 13mm wide. Silver Plated.

KO1284

Overall length 8-1/4in (21cm).



TAKA Brain Spatulas  
Stainless Steel. Malleable.  
Overall length  
8in (20cm).

KO1285

2.2mm tip.

KO1286

3.8mm tip.

KO1287

5.8mm tip.

KO1288

7mm tip.



TAKA Super Flexible  
Brain Spatulas  
Ebonized. Malleable.  
Overall length  
9in (22.9cm).

KO1289

2.2mm tip.

KO1290

3.8mm tip.

KO1291

5.8mm tip.

KO1292

7mm tip.



DAVIS Spatula  
Semi-sharp.  
Mirror and Satin finish.

KO1293

Overall length  
7-5/8in (19.4cm).



SACHS Nerve  
Separator Spatula  
One-piece construction.



KO1294

Overall length  
7-3/4in (19.7cm).



Spatulas  
Knurled handle.

KO1295

Overall length  
6-3/4in (17cm).

KO1296

Overall length  
8-1/2in (21.6cm).



HORSLEY Dura  
Separator  
Tempered Steel blade,  
45mm x 6.5mm wide.

KO1297

Overall length  
6-3/4in (17.2cm).



CARROLL-Type  
Periosteal Elevator  
Double-ended.  
Round blade 3mm wide.  
Flat blade 10mm wide.

KO1298

Overall length  
5-1/2in (14cm).

KO1301

5mm x 9mm blades.



MURPHY Ball Retractor  
Overall length  
9in (23cm).

KO1300

2.3mm ball tip.





FRAZIER Dura Elevator  
One-piece construction.

KO1302

Overall length  
6-1/4in (16.0cm).



PENFIELD Dissector  
No. 1  
Double-ended, broad  
curved dissector and  
sharp round spoon.

KO1303

Overall length  
7-1/2in (19.1cm).



PENFIELD Dissector  
No. 2  
Double-ended, curved  
dissector and wax packer.

KO1304

Overall length  
7-3/8in (18.7cm).



PENFIELD Dissector  
No. 3  
Double-ended, fully curved  
dissector and wax packer.

KO1305

Overall length  
7-1/4in (18.4cm).



PENFIELD Dissector  
No. 4  
Light, slightly curved.

◆ KO1306

Overall length  
8-1/2in (21.6cm).



PENFIELD Dissector  
No. 5  
Double-ended, slightly  
curved dissector ends.

KO1307

Overall length  
11-1/2in (29.2cm).



SUNDT Ball Tip  
Dissector  
Matte and Mirror finish.

KO1308

Overall length  
7in (17.8cm).



CRILE Knife and  
Dissector  
Double-ended.

KO1309

Overall length  
8-1/2in (21.6cm).



**JACOBSON**  
Vessel Knife  
Pointed, concave blade.



KO1310

Overall length  
7-1/4in (18.4cm).



**ADSON** Sharp Knife



KO1311

Overall length  
8in (20.3cm).



**ADSON**  
Aneurysm Needle  
Angled right.  
Tip 2mm wide.



KO1312

Overall length  
9in (22.9cm).



**JACOBSON** Probe  
Angled, ball-pointed tip.  
Mirror and Satin finish.



KO1313

Overall length  
7-1/4in (18.4cm).



**JACOBSON** Probe  
Straight, two ball tips. Mirror  
and Satin finish.



KO1314

Overall length  
7-1/4in (18.4cm).



**KILNER** Sharp Hook  
Hook diameter 2mm. Solid  
knurled handle.



KO1315

Overall length  
6in (15.2cm).



**FRAZIER** Dura Hook  
Hollow handle.

KO1316

Overall length  
6in (15.2cm).



**GRAHAM** Blunt Hook  
One-piece construction.

KO1317

Overall length  
6-1/2in (16.5cm).



**CLOWARD Dural Hook**  
Sharp hook.  
Hook diameter 2.5mm.

**KO1318**  
Overall length  
6-7/8in (17.5cm).



**KRAYENBUEHL Hook**  
Smooth end, with finger rest.  
Overall length  
7-1/4in (18.4cm).

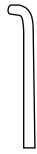

**KO1319**  
Small.



**KRAYENBUEHL Hooks**  
Probe pointed tip, with finger rest. Overall length  
7-3/8in (18.7cm).

**KO1320**  
Small.  
  
**KO1321**  
Large.



**WEARY-Type Nerve Hook**  
Tip diameter 0.9mm,  
depth 3mm. Black finish.

**KO1322**  
Overall length  
7-3/4in (19.7cm).



**ADSON Dural Hook**  
Hollow handle.  
Sharp tip, 5mm long.

**KO1323**  
Overall length  
8in (20.3cm).



**ADSON Dissecting Hook**  
Blunt hook, depth 5mm.

**KO1324**  
Overall length  
8in (20.3cm).



**ADSON Blunt Dissecting Hook**  
Tip length 5mm.

**KO1325**  
Overall length  
8-1/4in (20.8cm).



**SMITHWICK Nerve Hook**

**KO1326**  
Overall length  
8-1/4in (21cm).



**DANDY Nerve Hooks**  
Overall length  
8-1/2in (21.6cm).

**KO1327**

Pointed left.

KO1328  
Straight.

KO1329  
Pointed right.



**Nerve Hook**

**KO1330**

Overall length  
9-1/2in (24.1cm).



**YASARGIL Spring Hook**

**KO1331**

Large.



**CAIRNS (DANDY)  
Hemostasis Forceps**  
Curved on side.

**KO1332**

Overall length  
5-1/2in (14cm).



**ADSON Hemostatic Forceps**



**KO1333**  
Straight.  
Overall length  
8-1/2in (21.6cm).



**KO1334**  
Curved.  
Overall length  
8-1/2in (21.6cm).



**KO1335**  
Straight.  
Overall length  
7-1/4in (18.4cm).

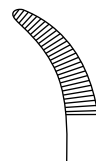

◆ **KO1336**  
Curved.  
Overall length  
7-1/4in (18.4cm).



Spinal Ligament Forceps  
Serrated tips. 1 x 2 teeth.

KO1337

Overall length  
7-1/4in (18.4cm).



ACLAND Microvascular Clamp  
Applying Forceps  
Straight.

KO1338

Overall length  
4-3/8in (11cm).



ACLAND Single Clamps

KO1339

Overall length  
8mm.

KO1340  
Overall length  
11mm.

KO1341  
Overall length  
14mm.

KO1342  
Overall length  
17mm.



ACLAND Double Clamps  
With frame for stay sutures.

KO1343

Overall length  
8mm.

KO1344  
Overall length  
11mm.



ACLAND Double Clamp Approximators  
Movable.



With Frame Cat. No.	Without Frame Cat. No.	Length
KO1345	KO1346	8mm
	KO1347	11mm
	KO1348	14mm
	KO1349	17mm



**CUSHING Pituitary Spoons**  
Silver Plated. Overall length 9-1/4in (23.5cm).



KO1350

Small, size 1.



KO1351

Large, size 3.



NL2901

Medium, size 2.



**APFELBAUM Micro Mirrors**  
Round, knurled handle, malleable shaft.  
Matte and Mirror finish. Working length  
4-1/2in (11.4cm).

KO1352

4mm diameter glass mirror.

KO1353

6mm diameter glass mirror.



**STEVENSON Alligator Scissors**  
Delicate. Working length 5-3/8in (13.7cm).

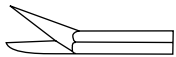

KO1354

Sharp/Sharp.

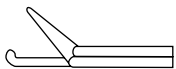

KO1356

With 1.5mm guard on  
blunt dissector.



**JANNETTA-KURZE (Modified) Dissecting Scissors**  
Curved to the left. Blade length 8.5mm.

KO1355

Working length  
5-3/8in (13.7cm).

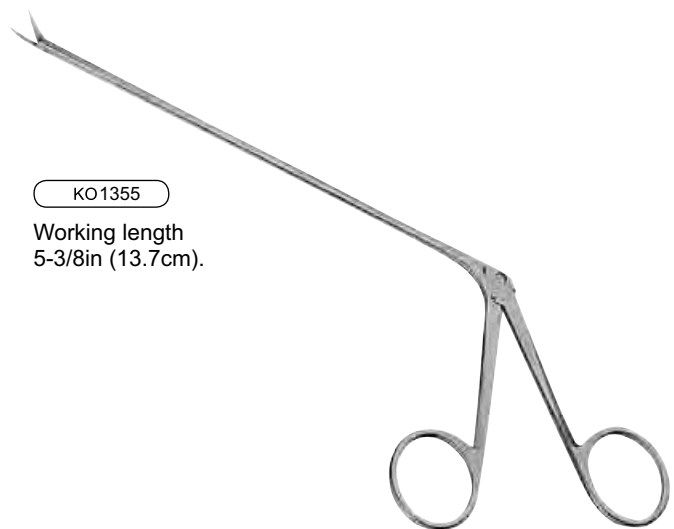

KURZE Dissecting Scissors  
Blade length 9mm. Working length 5-1/2in (13.7cm).

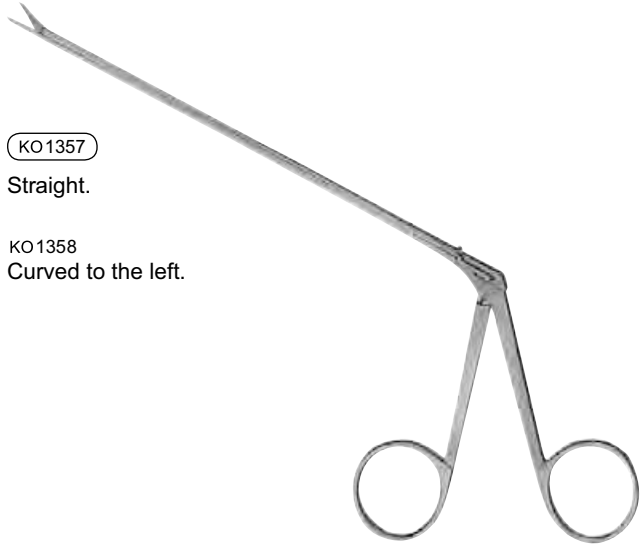

KO1357

Straight.

KO1358  
Curved to the left.

KURZE Dissecting Scissors.  
Curved to right.

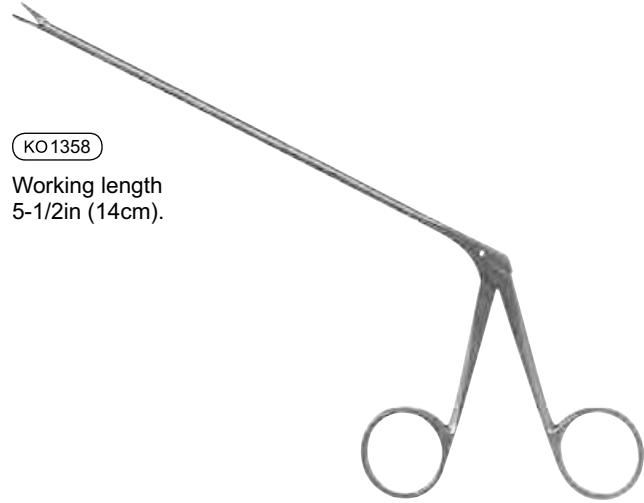

KO1358

Working length  
5-1/2in (14cm).

TINDALL Scissors  
Blades angled up.

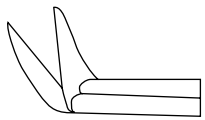
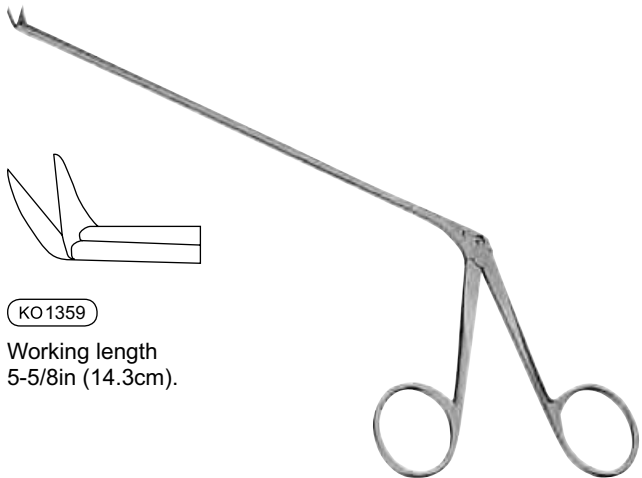

KO1359

Working length  
5-5/8in (14.3cm).

Microsurgery Scissors  
Pencil-grip type handle.  
Overall length  
7-1/4in (18.4cm).

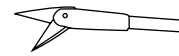

KO1360

Straight blades.

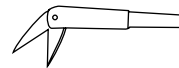

KO1361  
Angled blades.



**YASARGIL Micro Scissors**  
Bayonet shaped.

KO1362  
Curved upward.  
Blade length 11mm.  
Overall length  
6-1/2in (16.5cm).

**KO1363**  
Straight.  
Blade length 11.5mm.  
Overall length  
6-1/2in (16.5cm).

KO1364  
Curved downward.  
Blade length 12mm.  
Overall length  
8in (20.3cm).

KO1372  
Curved upward.  
Blade length 12mm.  
Overall length  
8in (20.3cm).

KO1365  
Straight.  
Blade length 12.5mm.  
Overall length  
8in (20.3cm).

KO1366  
Straight.  
Overall length  
9in (22.9cm).



**MALIS Titanium Bayonet Scissors**  
Working length 3-3/4in (9.5cm).  
Overall length 9-1/2in (24.1cm).

**KO1367**  
Straight. Regular tips.

KO1368  
Curved. Regular tips.

KO1369  
Curved down. Regular tips.

KO1370  
Straight. Delicate tips.

KO1371  
Curved up. Delicate tips.

**titanium**



**YASARGIL Micro Scissors**  
Overall length 8-3/4in (22.2cm).

KO1373  
Tapered tip, curved upward.  
Blade length 12.5mm.

**KO1374**  
Straight.  
Blade length 16.5mm.

KO1375  
Curved upward.  
Blade length 16.5mm.



**JANNETTA Bayonet Shaped Scissors**  
Very delicate curved blades, sharp points.  
Blade length 9mm.  
Spring handle.

**KO1376**  
Overall length  
7-1/4in (18.4cm).



**TAYLOR Brain Scissors**  
Angled-on-side, slightly curved shanks, one probe-tipped blade. Mirror finish.

**KO1377**  
Overall length  
6in (15.2cm).

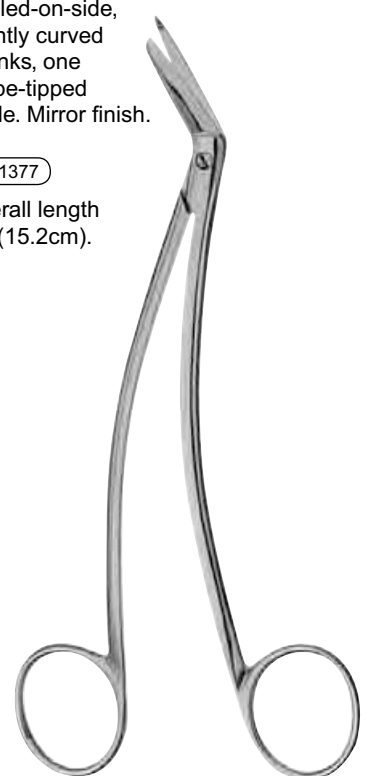

**DANDY Neurosurgical Scissors**  
Shanks angled-on-flat.

KO1378

Overall length  
6-3/4in (17.1cm).



**MALIS Scissors**  
Semi-sharp tips.  
Curved.

KO1379  
Overall length  
7in (17.8cm).



**DeMARTEL Scissors**  
Sharp/Sharp. Delicate.  
Curved blades, length  
3cm from mid-screw.  
Mirror finish.

KO1380

Overall length  
7-3/4in (19.6cm).



**STRULLY Dissecting Scissors**  
Curved blades, probe tips.

KO1381

Overall length  
8-3/4in (22.2cm).



**Vital<sup>®</sup> Microsurgical Needle Holders**  
Tungsten Carbide inserts.

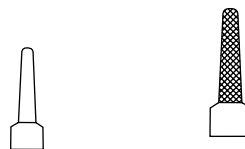

Smooth jaws.  
Overall length  
5in (12.7cm).



Finely cross-serrated jaws.  
3,600 teeth per square inch.  
Overall length  
5in (12.7cm).



KO1382

Finely cross-serrated jaws.  
3,600 teeth per square inch.  
Overall length  
6in (15.2cm).



Micro-Tubal Needle Holders



KO1383

Curved jaws.  
Overall length  
7in (17.8cm).



Micro Forceps  
Straight, without platform.



KO1384

Overall length  
6in (15.2cm).



Micro Tissue Forceps  
Straight. 1 x 2 teeth.  
Size 0.3mm. 6mm platform.



KO1385

Overall length  
6in (15.2cm).



Micro Forceps  
1cm platform.  
Overall length 6in (15.2cm).



KO1386

Curved.



Straight.





**GERALD Forceps**  
Delicate.



◆ **KO1387**  
1 x 2 teeth.  
Overall length  
7in (17.8cm).



◆ **KO1388**  
Serrated tips.  
Overall length  
7in (17.8cm).



**GERALD Forceps**  
Straight. Flat handle. Serrated tips.



**KO1389**  
Overall length  
9-1/4in (23.5cm).



**GERALD-DeBAKEY Tissue Forceps**  
Tips 1mm wide.



**KO1390**  
Overall length  
7in (17.8cm).

**KO1400**  
Overall length  
8in (20.3cm).



**Vital ® Micro GERALD Forceps**

**KO1401**  
Fine tips tapered to 1mm wide.  
Overall length 7in (17.8cm).



**KO1402**  
Delicate, extra-fine tips  
tapered to 1mm wide.  
Overall length 7in (17.8cm).

**KO1403**  
Delicate, extra-fine tips  
tapered to 1mm wide.  
Overall length 9in (22.9cm).



**CUSHING Dressing Forceps**  
Serrated. Semi-sharp dissecting end.



**KO1404**  
Overall length  
7in (17.8cm).

**KO1405**  
Overall length  
8in (20.3cm).



**CUSHING Dressing Forceps**  
Bayonet. Serrated,  
square dissecting tip.

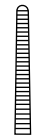

◆ **KO1406**  
Overall length  
7-5/8in (19.4cm).



CUSHING Tissue Forceps  
1 x 2 teeth. Semi-sharp dissecting end.



◆ (KO1407)

Overall length  
7-1/4in (18.4cm).

KO1408  
Overall length  
8in (20.3cm).



CUSHING Tissue Forceps  
Gutsch handle.  
Overall length 7in (17.8cm).

(KO1409)

Serrated tips.

KO1410  
1 x 2 teeth.

KO1411  
Serrated tips.  
1 x 2 teeth.



CUSHING Tissue Forceps  
Bayonet. Serrated. 1 x 2 teeth.  
Square dissecting tip.

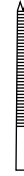

(KO1412)

Overall length  
7-5/8in (19.4cm).



Vital ® CUSHING Tissue Forceps  
Straight. Delicate jaws.  
Tungsten Carbide inserts.  
3,600 teeth per square inch.



(KO1413)

Overall length  
7in (17.8cm).



Vital ® CUSHING Tissue Forceps  
Angled tips. Tungsten  
Carbide inserts.  
3,600 teeth per square inch.



(KO1414)

Overall length  
6-3/4in (17cm).



Vital ® CUSHING Tissue Forceps  
Bayonet. Tungsten  
Carbide tips  
and dissecting end.



(KO1415)

Overall length  
7-1/4in (18.5cm).



ADSON Dressing Forceps  
Bayonet. Fine, serrated tips.



KO1416

Overall length  
7-1/8in (18.1cm).



D'ERRICO Tissue Forceps  
1 x 2 teeth.



KO1417

Overall length  
7-1/4in (18.4cm).



D'ERRICO Dressing Forceps  
Bayonet shape. Serrated.



KO1418

Overall length  
8-7/8in (22.5cm).



D'ERRICO Hypophyseal Forceps  
Bayonet shaped, straight shanks.  
Overall length 8-3/4in (22.2cm).

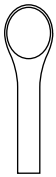

KO1419

Cupped jaws,  
6.5mm x 6.5mm.

KO1420

Cupped jaws,  
3mm x 3mm.

KO1421

Cupped jaws,  
5mm x 5mm.



MALIS Titanium Bayonet Forceps  
Working length 3-1/2in (8.9cm).  
Overall length 8-3/4in (22.2cm).

KO1422

Straight. Delicate tips.



*Looking for a specific product?*

When you know the catalog number or the name of the product you need, you can use the index at the end of this book to direct you to the page on which the product is described. If you do not find the specific instruments.

**HAYNES Brain Cannulas**  
Graduated in centimeters.  
Diameter 13GA. Mirror finish.

**KO1423**

Working length  
4in (10.2cm).



**CONE Ventricular Needles**  
Mirror finish. Working length  
3-1/2in (8.9cm).

KO1424  
With 1 hole.  
Diameter 16GA.

KO1425  
With 1 hole.  
Diameter 18GA.

**KO1426**  
With 2 holes.  
Diameter 16GA.

KO1427  
With 2 holes.  
Diameter 18GA.



**FRAZIER Ventricular Cannulas**  
Graduated in centimeters.  
Diameter 12GA.  
Mirror finish.

**KO1428**

Working length  
2in (5.2cm).

KO1429  
Working length  
2-1/8in (5.4cm).

KO1430  
Working length  
3-1/2in (8.9cm).



**ADSON Exploring Cannulas**  
Graduated in centimeters.  
Mirror finish.  
Working length  
4in (10.2cm).

KO1431  
Diameter 10GA.

**KO1432**  
Diameter 14GA.



**CONE Biopsy Cannulas**  
Mirror finish.  
Working length  
3-1/2in (8.9cm).

**KO1433**  
13GA.

KO1434  
15GA.



**Microsurgery Biopsy Forceps**  
Straight. Cup-shaped jaws.  
Diameter 1mm.  
Pencil-grip type handle.



**KO1435**  
Overall length  
7-1/4in (18.4cm).



STEVENSON Grasping Forceps  
Straight. 6mm jaws. Alligator type shank.

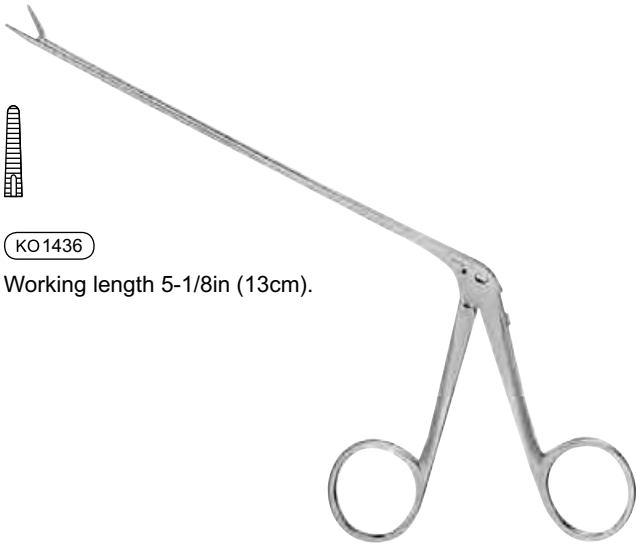

KO1436

Working length 5-1/8in (13cm).

STEVENSON Cupped Jaw Forceps  
Alligator type shank. Working length 5-1/8in (13cm).

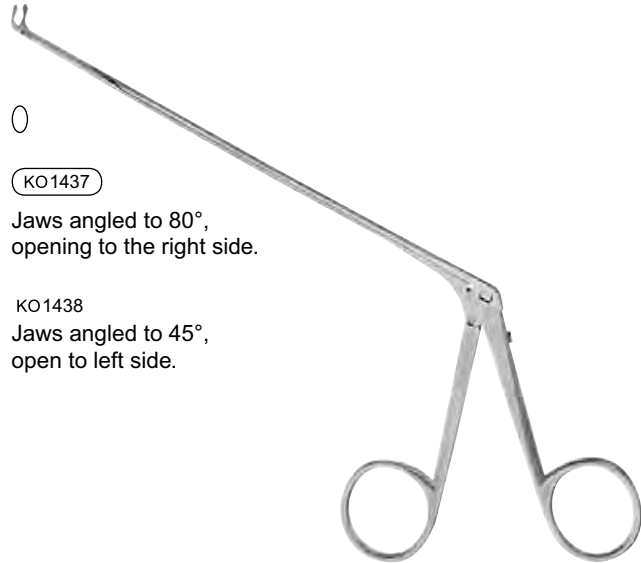

KO1437

Jaws angled to 80°,  
opening to the right side.

KO1438

Jaws angled to 45°,  
open to left side.

JANNETTA Alligator Grasping  
Forceps  
Delicate. Working length 5-3/8in (13.7cm).

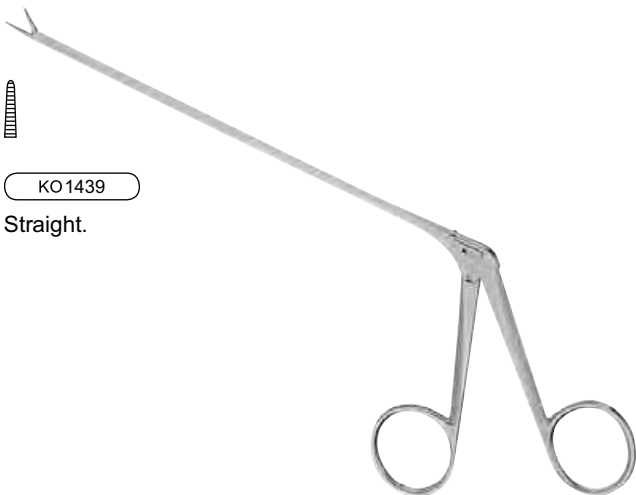

KO1439

Straight.

#### Customer Support

Our highly trained, centralized V. Mueller customer support team is available to take your calls from 7:00 a.m. to 6:00 p.m. (CST), M-F. This group is dedicated to providing a full range of support services, including:

- Order placement
- Order inquiries
- Delivery information
- Product information
- Pricing inquiries

RHOTON Micro Scissors  
Blades angled 60°. Overall length 6-7/8in (17.5cm).

KO1440

KO1441  
Blades curved right.

KO1442  
Blades curved left.



RHOTON Micro Surgical Scissors  
Cutting blades 5.5mm long.

KO1443

Straight.  
Overall length  
7-1/2in (19.1cm).

KO1444  
Blades angled up 45°. Overall length  
7-3/8in (18.7cm).

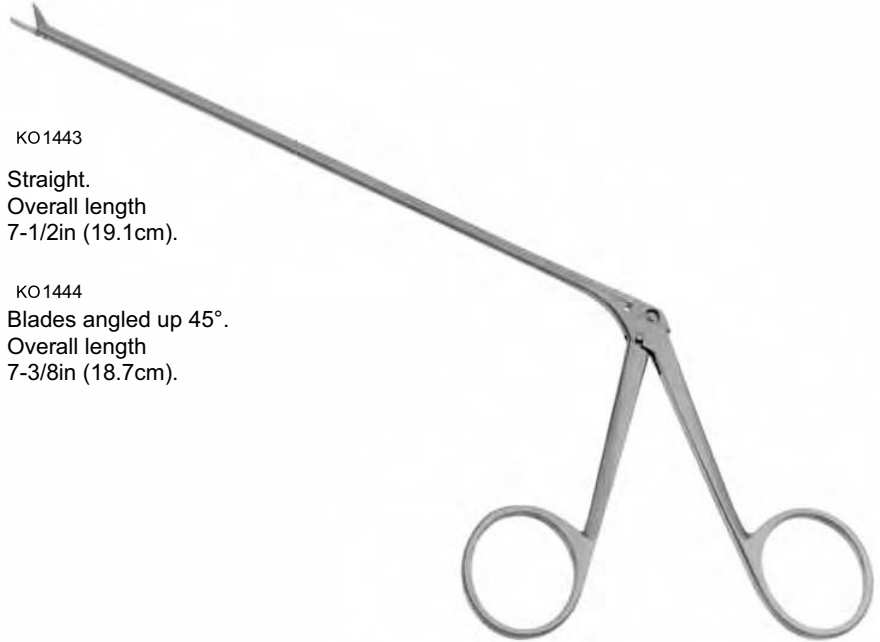

RHOTON Micro Scissors  
Mirror and Satin finish.  
Overall length  
7in (17.8cm).

KO1445

Straight.

KO1446  
Curved.



RHOTON Micro Needle Holders  
Round handle. Overall length  
7in (17.8cm).



KO1447

Straight jaws.



KO1448  
Curved jaws.



RHOTON Micro Needle Holders  
With catch. Overall length  
7in (17.8cm).



KO1449

Straight jaws.



KO1450  
Curved jaws.





RHOTON Micro Tying Forceps  
0.75mm tip. Overall length  
7in (17.8cm).



KO1451

Straight.



Curved.



RHOTON Micro Forceps  
Straight. Overall length  
7in (17.8cm).



KO1452

Extra-fine. 0.3mm tips.



Fine. 0.5mm tips.



RHOTON-ADSON Dressing Forceps  
Serrated.

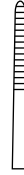

KO1453

Overall length  
7-1/8in (18.1cm).



RHOTON-ADSON Tissue Forceps  
1 x 2 teeth.



KO1454

Overall length  
7-1/8in (18.1cm).



RHOTON Tissue Forceps  
Straight. 1 x 2 teeth.



KO1455

Overall length  
7in (17.8cm).



RHOTON Micro Vascular Forceps  
Straight. Serrated tips, 3mm wide with groove  
down middle.



KO1456

Overall length  
7-1/8in (18.1cm).



**RHOTON Bayonet Scissors**  
Mirror and Satin finish.

KO1457

Straight 8cm shaft.  
Overall length  
8-3/8in (21.3cm).

KO1458

Curved 8cm shaft.  
Overall length  
8-3/8in (21.3cm).

KO1459

Straight 9.5cm shaft.  
Overall length  
9-1/8in (23.2cm).

KO1460

Curved 9.5cm shaft.  
Overall length  
9-1/8in (23.2cm).

KO1461

Straight extra-long  
11cm shaft.  
Overall length  
9-7/8in (25.1cm).

KO1462

Curved extra-long  
11cm shaft.  
Overall length  
9-7/8in (25.1cm).



**RHOTON Bayonet Needle Holders**



KO1463

Straight 8cm shaft.  
Overall length  
9-1/4in (23.5cm).

KO1464

Straight 6cm shaft.  
Overall length  
8-1/4in (21cm).



KO1465

Curved 8cm shaft.  
Overall length  
9-1/4in (23.5cm).

KO1466

Curved 6cm shaft.  
Overall length  
8-1/4in (21cm).



**RHOTON-CUSHING Dressing Forceps**  
Serrated jaws, 8cm shaft.



KO1467

Overall length  
7-7/8in (20cm).



**RHOTON-CUSHING Tissue Forceps**  
1 x 2 teeth. Tips 5mm.  
Shaft 8cm.



KO1468

Overall length  
7-7/8in (20cm).



**RHOTON Grasping Forceps**  
Serrated ring tip,  
2.6mm.

KO1469

Shaft 8cm.  
Overall length  
8in (20cm).



KO1470

Shaft 9.5cm.  
Overall length  
9in (22.9cm).



**RHOTON Micro Dissecting Forceps**  
Bayonet. Finely serrated  
tips .75mm.



KO1471

Shaft length 11cm.  
Overall length  
9-3/8in (23.8cm).



RHOTON Cup Forceps  
Cup 0.5mm wide.  
Working length 5-3/8in (13.7cm).

KO1472

Straight.

KO1473  
Angled right.

KO1474  
Angled left.



RHOTON Cup Forceps  
Cup 1mm wide. Working length  
5-3/8in (13.7cm).

◆ KO1475

Straight.

KO1476  
Angled right.

KO1477  
Angled left.

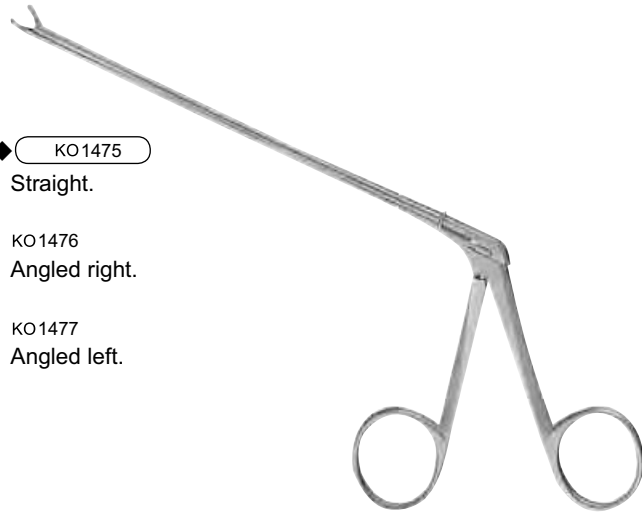

RHOTON Cup Forceps  
Straight. Working length  
5-3/8in (13.7cm).

◆ KO1478

Cup 2mm wide.

◆ KO1479  
Cup 3mm wide.

KO1480  
Cup 4mm wide.

KO1481  
Cup 5mm wide.

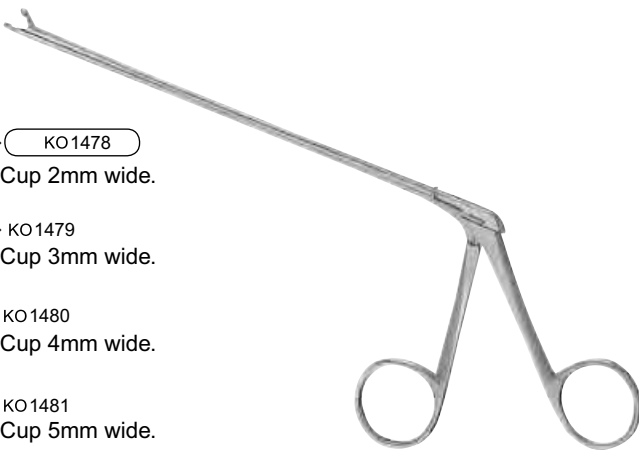

RHOTON Punches  
Working length 8in (20.3cm).  
Overall length  
10-3/4in (27.3cm).

KO1482  
Upcutting, 45°. 1mm wide.



KO1483  
Upcutting, 90°. 1mm wide.

KO1484  
Downcutting, 90°. 1mm wide.

KO1485  
Upcutting, 45°. 2mm wide.



KO1486  
Upcutting, 90°. 2mm wide.

KO1487  
Downcutting, 90°. 2mm wide.

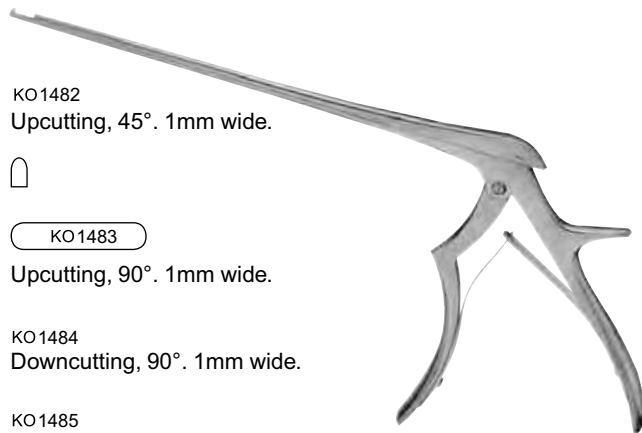

RHOTON Microsurgical Instruments  
Complete set of  
20 instruments in rack.

KO440  
Includes NL3785-001  
through NL3785-20.

**titanium**

RHOTON Round  
Dissectors  
Overall length  
7-1/2in (19.1cm).



KO1488

Diameter 1mm.

KO1489  
Titanium. Diameter 1mm.

KO1490  
Diameter 2mm.

KO1491  
Titanium. Diameter 2mm.

KO1492  
Diameter 3mm.

KO1493  
Titanium. Diameter 3mm.

**titanium**

RHOTON General  
Purpose Elevators  
Overall length  
7-1/2in (19.1cm).



KO1494

Curved.

KO1495  
Titanium. Curved.

KO1496  
Angled.

KO1497  
Titanium. Angled.

**titanium**

RHOTON Spatula  
Dissectors  
Overall length  
7-1/2in (19.1cm).

KO1498

No. 6. Small.

KO1499  
Titanium. No. 6. Small.

KO1500  
No. 7. Medium.

KO1501  
Titanium. No. 7. Medium.



KO1502  
No. 8. Large.

KO1503  
Titanium. No. 8. Large.

**titanium**

RHOTON Hooks  
Overall length  
7-1/2in (19.1cm).



KO1504

Angled 90°.  
Semi-sharp.

KO1505  
Titanium. Angled 90°.  
Semi-sharp.

KO1506  
Angled 90°. Blunt.

KO1507  
Titanium. Angled 90°.  
Blunt.

KO1508  
Angled 45°.  
Semi-sharp.

KO1509  
Titanium. Angled 45°.  
Semi-sharp.

**titanium**

RHOTON Straight  
Point Needle  
No. 12. Semi-sharp.

KO1510

Overall length  
7-1/2in (19.1cm).

KO1511  
Titanium.  
Overall length  
7-1/2in (19.1cm).

**titanium**

RHOTON Micro  
Curettes  
Cup 2mm x 1mm wide.  
Overall length  
7-1/2in (19.1cm).



KO1512

Straight.

KO1513  
Titanium. Straight.

KO1514  
Angled.

KO1515  
Titanium. Angled.

**titanium**

RHOTON Angled  
Meatal Curette  
Cup 2mm x 1mm wide.  
Overall length  
7-3/8in (18.7cm).

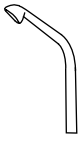

KO1516  
Angled 130°.

RHOTON Ball Dissector  
Diameter 0.8mm. Straight.  
Mirror and Satin finish.



KO1517  
Overall length  
7-1/2in (19.1cm).  
  
KO1518  
Titanium.  
Overall length  
7-1/2in (19.1cm).

RHOTON Ball Dissectors  
Mirror and Satin finish.  
Overall length  
7-1/2in (19.1cm).

KO1519  
Tip 3mm wide.  
Angled 90°.

KO1520  
Titanium. Tip 3mm wide.  
Angled 90°.

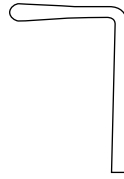

KO1521  
Tip 5mm wide.  
Angled 90°.

KO1522  
Titanium. Tip 5mm wide.  
Angled 90°.



KO1523  
Tip 4mm wide.  
Angled 40°.

KO1524  
Titanium. Tip 5mm wide.  
Angled 40°.

KO1525  
Tip 8mm wide.  
Angled 40°.

KO1526  
Titanium. Tip 8mm wide.  
Angled 40°.

#### V. Mueller Instrument Detergents

To assist with the care and handling of your instruments, CareFusion offers you a full line of cleaning and decontamination products detailed in the Small. Blades 3-12in (8.9cm). Genesis Sterilization Containers and Instrument Processing Supplies section of this armamentarium.

#### RHOTON Transsphenoidal Specula

KO1527

Rhoton Transsphenoidal Specula.  
Large. Blades 4in (101.6cm).



**RHOTON Knife Handle**  
Vertical, takes No. 11 blade.

KO1528

Overall length  
7-5/8in (19.4cm).



**RHOTON Enucleators**  
Overall length  
9in (22.9cm).



KO1529  
Small size, right.

KO1530  
Small size, left.



KO1531

Regular size, right.

KO1532  
Regular size, left.



**RHOTON Round Dissector Sharp.**



KO1532

Overall length  
9in (22.9cm).



**RHOTON Spatula Dissectors**  
Overall length  
9in (22.9cm).



KO1533

Curved up.



KO1534  
Curved down.



**RHOTON Hook**  
Right angled, 3.5mm.



KO1535

Overall length  
9in (22.9cm).



**RHOTON Vertical Ring Curettes**  
Blunt. Overall length  
9in (22.9cm).

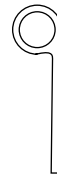

KO1536

Diameter 6mm.

KO1537  
Diameter 3mm.

KO1538  
Diameter 9mm.





**RHOTON Horizontal Ring Crettes**  
Blunt. Overall length 9in (22.9cm).

- KO1539**  
Diameter 6mm.
- KO1540**  
Diameter 9mm.
- KO1541**  
Diameter 3mm.



**RHOTON Three-Prong Fork**  
Sharp prongs.

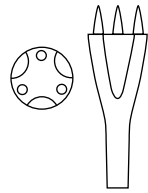

**KO1542**  
Overall length 9in (22.9cm).



**RHOTON Micro Curette**  
Angled 45°.



**KO1543**  
Overall length 9in (22.9cm).



**RHOTON Pituitary Crettes**  
Overall length 9in (22.9cm).

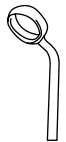

**KO1544**  
Horizontal, angled 45°.

**KO1555**  
Vertical.



**RHOTON Loop Curette**  
Blunt. Loop faces sideways, 9mm x 5mm wide. Malleable.

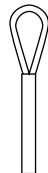

**KO1556**  
Overall length 9in (22.9cm).



**RHOTON Spoon Curette**  
Blunt. Cup faces up, 9mm x 5mm wide. Malleable. Stainless Steel.



**KO1557**  
Overall length 9in (22.9cm).



**RHOTON Osteotome**  
Especially suited for making initial opening in anterior sellar wall. 4mm wide.

**KO1558**  
Overall length 7-1/2in (19.1cm).



**JANNETTA Angular Knives**  
 Mirror and Satin finish. Overall length 7-1/2in (19.1cm).



KO1559

Small, 2mm diameter.



KO440

Large, 2.5mm diameter.



**JANNETTA Duckbill Elevator**  
 Curved tip, 2.7mm wide. Angled shaft.



KO1560

Overall length 7-1/2in (19.1cm).



**JANNETTA Angular Elevator**  
 Tip 1.1mm wide.



KO1561

Overall length 7-1/2in (19.1cm).



**JANNETTA Dissectors**  
 Curved blade. Overall length 7-1/2in (19.1cm).

KO1562

Small. Tip 1.6mm wide.



KO1563

Large. Tip 2mm wide.



**JANNETTA Right Angle Hooks**  
 Overall length 7-1/2in (19.1cm).



KO1564

Small. Tip length 2mm.

KO1565

Medium. Tip length 3.5mm.

KO1566

Large. Tip length 4.7mm.



*Custom etching*

Custom etching is available on stainless steel surgical instruments on new orders as they are purchased.

**JANNETTA Probe**  
 Small. Tip length 1.7mm.  
 Angled 45°.



**KO1567**  
 Overall length  
 7-1/2in (19.1cm).



**JANNETTA Hook**  
 Medium. Tip length 2.8mm.  
 Angled 45°.



**KO1568**  
 Overall length  
 7-1/2in (19.1cm).



**JACOBSON-Type Probe**  
 0.7mm diameter ball tip.  
 Tip length 10mm.



**KO1569**  
 Overall length  
 7-1/2in (19.1cm).



**JANNETTA Double Prong Forks**  
 Angled 30°. Overall length  
 7-1/2in (19.1cm).



**KO1570**  
 Small. 1.3mm wide.  
  
 KO1571  
 Large. 2mm wide.



**JANNETTA Aneurysm Neck Dissectors**  
 Ligature carrier. Suture hole in blade.  
 Overall length 7-1/2in (19.1cm).



**KO1572**  
 Right.  
  
 KO1573  
 Left.



**JANNETTA Forceps Bayonet.** Overall length  
 6-1/4in (15.9cm).



**KO1574**  
 Fine, smooth points.



**KO1575**  
 Fine, serrated points.

**KENNERDELL-MAROON Orbital Retractor Set**  
Self-retaining, versatile in adaptability,  
designed for greater exposure.

KO1576

Includes the following:

- KO1577 One Retractor Frame with three posts.
  - KO1578 Four Round Extension Rods, length 3-3/4in (9.5cm).
  - KO1579 Five Universal Swivel Connectors.
  - KO1580 Two Blades, 50mm x 5mm wide. Malleable. Copper.
  - KO1581 Three Blades, 50mm x 8mm wide. Malleable. Copper.
  - KO1582 Three Blades, 50mm x 15mm wide. Malleable. Copper.
- Individual parts are also available as needed.



**Round Extension Rod**

KO1583

Overall length  
3-3/4in (9.5cm).



**Universal Swivel Connector**

KO1584



**KENNERDELL-MAROON  
Orbital Retractor  
Blades**

KO1585

50mm x 5mm wide.  
KO1586  
NL1175-005  
50mm x 8mm wide.

KO1587  
50mm x 15mm wide.



**KENNERDELL-MAROON  
Dissector  
Round.  
Diameter 2.5mm.**

KO1588

Mirror and Satin finish.



**YASARGIL Round Tip Micro Scissors**  
Straight.

KO 1589

Overall length  
6-1/4in (15.9cm).



**YASARGIL Round Tip Micro Scissors**  
Bayonet shape, straight blades.

KO 1590

Working length  
3-7/8in (9.8cm).  
Overall length  
7-1/2in (19.1cm).

KO 1591  
Working length  
4-3/4in (12cm).  
Overall length  
8-1/4in (21cm).



**YASARGIL Micro Scissors**  
Bayonet shaped.

KO 1592

Straight.  
Blade length 11.5mm.  
Overall length 6-1/2in (16.5cm).

KO 1593  
Curved upward.  
Blade length 11mm.  
Overall length  
6-1/2in (16.5cm).

KO 1594  
Straight.  
Blade length 12.5mm.  
Overall length 8in (20.3cm).

KO 1595  
Curved upward.  
Blade length 12mm.  
Overall length 8in (20.3cm).

KO 1596  
Curved downward.  
Blade length 12mm.  
Overall length 8in (20.3cm).



**YASARGIL Micro Scissors**

KO 1597  
Tapered tip, curved upward.  
Blade length 12.5mm.  
Overall length  
8-3/4in (22.2cm).

KO 1598

Straight.  
Blade length 16.5mm.  
Overall length  
8-3/4in (22.2cm).

KO 1599  
Curved upward.  
Blade length 16.5mm.  
Overall length  
8-3/4in (22.2cm).



**YASARGIL Bayonet Scissors**

KO 1600

Straight blades.  
Overall length  
7-1/4in (18.4cm).

KO 1601  
Curved blades.  
Overall length  
7-1/4in (18.4cm).

KO 1602  
Extra-fine straight blades.  
Overall length  
8-3/4in (22.2cm).



**YASARGIL Bayonet Scissors**

Overall length  
7-1/2in (19.1cm).

KO 1603

Straight blades.

KO 1604  
Blades angled sideward.



**YASARGIL Forceps**  
Bayonet. Smooth jaws.



**KO1605**

Overall length  
7-1/2in (19.1cm).



**YASARGIL Forceps**  
Bayonet. 1 x 2 teeth.



**KO1606**

Overall length  
8in (20.3cm).



**YASARGIL Scoop**  
Bayonet shank with round handle.



**KO1607**

Overall length  
7-1/4in (18.4cm).



**YASARGIL Arachnoid Knives**  
Bayonet shank with round handle.  
Mirror and Satin finish.  
Overall length  
7-1/4in (18.4cm).

Blade curved backward.



**KO1608**

Blade curved forward.



**YASARGIL Raspatory**  
Rounded blade. Slightly curved.



**KO1609**

Overall length  
7-1/4in (18.4cm).



**YASARGIL Tissue Lifter**  
1mm diameter.



**KO1610**

Overall length  
7-1/4in (18.4cm).



**YASARGIL Ligature Guide and Carriers**  
Probe pointed.  
Overall length  
7-1/4in (18.4cm).

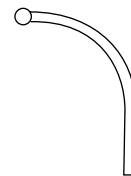

**KO1611**

1/2 curved.

KO1612  
5/8 curved.

KO1613  
3/4 curved.





**HARDY Currettes**  
 Bayonet. Working length 4-3/4in (12cm).  
 Overall length 9-1/2in (24.1cm).

KO1604  
 Angled up, 3mm.

KO1610  
 Angled up, 5mm.

KO1605  
 Angled down, 3mm.

KO1611  
 Angled down, 5mm.

KO1606  
 Angled 90° left, 3mm.

KO1612  
 Angled 90° left, 5mm.

KO1607  
 Angled 45° right, 3mm.

**KO1613**  
 Angled 45° right, 5mm.

KO1608  
 Curved right, 5mm.

KO1609  
 Curved left, 5mm.



**HARDY Dissector**  
 Sharp inner edge.  
 Turned downward on bayonet handle.



**KO1614**  
 Overall length  
 8-1/2in (21.6cm).



**MARINO Rotatable Transsphenoidal Knife Handle**

**KO1615**  
 Working length 4-1/8in (10.5cm). Overall length  
 9-1/8in (23.2cm)



**MARINO Rotatable Transsphenoidal Enucleator**  
 Working length 5-3/8in (13.7cm).  
 Overall length 10-1/2in (26.7cm).

KO1616  
 Small, right.  
 Tip 3mm wide.

**KO1617**  
 Small, left.  
 Tip 3mm wide.

KO1618  
 Regular, right.  
 Tip 3.8mm wide.

KO1619  
 Regular, left.  
 Tip 3.8mm wide.



**MARINO Rotatable Transsphenoidal Round Dissector**  
 Sharp. Mirror and Satin finish.

**KO1620**  
 Working length 5-3/8in (13.7cm).  
 Overall length 10-1/2in (26.7cm).



**MARINO Rotatable Transsphenoidal Spatula Dissector**

**KO1621**  
 Working length 5-3/8in (13.7cm).  
 Overall length 10-1/2in (26.7cm).



**MARINO Rotatable Transsphenoidal Right Angle Hook**  
 Mirror and Satin finish.

**KO1622**  
 Working length 5-3/8in (13.7cm).  
 Overall length 10-1/2in (26.7cm).



MARINO Rotatable  
Transsphenoidal  
Vertical Ring Curette  
Ring diameter 3mm.

KO1623

Working length  
5-3/8in (13.7cm).  
Overall length  
10-1/2in (26.7cm).



MARINO Rotatable  
Transsphenoidal  
Horizontal  
Ring Curette  
Working length  
5-3/8in (13.7cm).  
Overall length  
10-1/2in (26.7cm).

KO1624

Ring diameter 3mm.

KO1625  
Ring diameter 6mm.



MARINO Rotatable  
Transsphenoidal  
45° Horizontal  
Ring Curette  
Ring diameter 5mm.

KO1626

Working length  
5-3/8in (13.7cm).  
Overall length  
10-1/2in (26.7cm).



MARINO Rotatable  
Transsphenoidal  
Vertical  
Ring Curette  
Curved shaft, 5mm.

KO1627

Working length  
5-3/8in (13.7cm).  
Overall length  
10-1/2 in (26.7cm).



WARTENBERG Pinwheel

KO1628

Overall length  
7-3/8in (18.7cm).



CASPER-Style Caliper

KO1629



Customer Support

Our highly trained, centralized V. Mueller customer support team is available to take your calls from 7:00 a.m. to 6:00 p.m. (CST), M-F. This group is dedicated to providing a full range of support services, including:

- Order placement
- Order inquiries
- Delivery information
- Product information
- Pricing inquiries

# Neuro/Spine and Orthopedic Instruments

Retractors, Osteotomes, Curettes and  
Ronguer Forceps

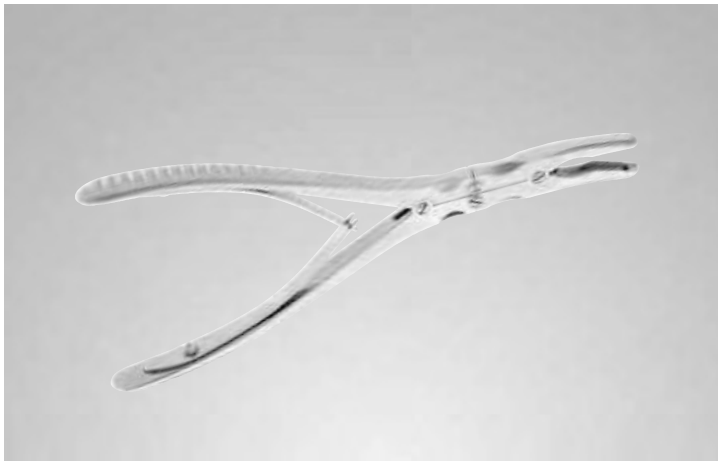
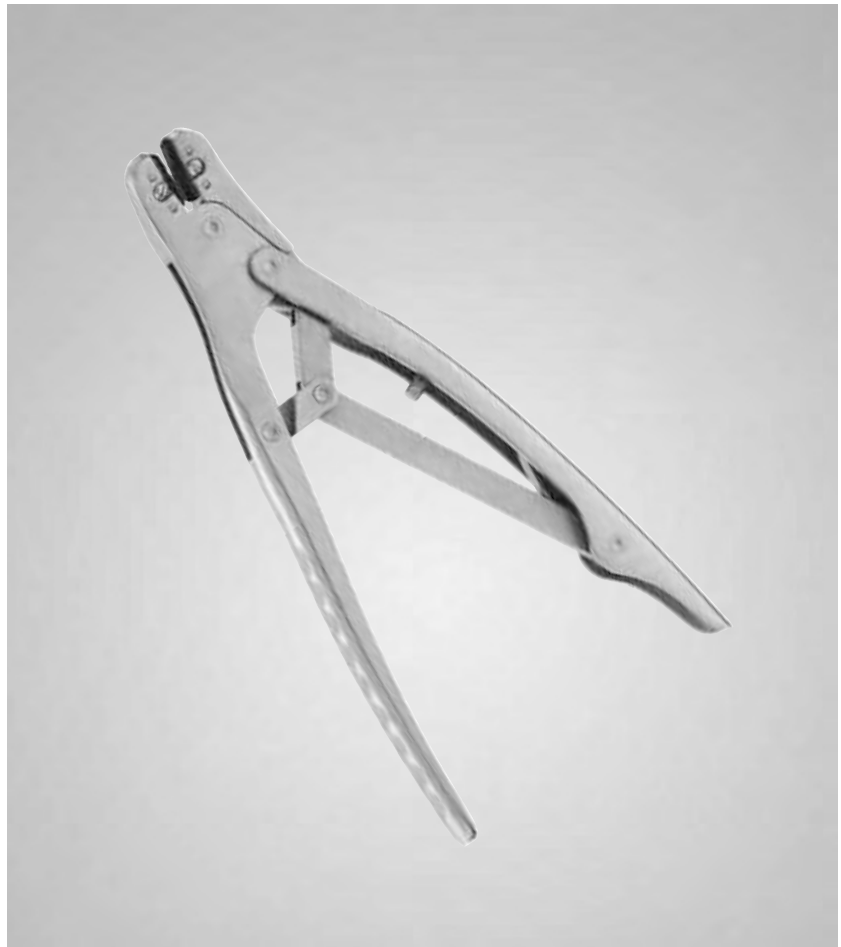

RAGNELL Retractor  
Delicate,  
double-ended.  
Blades 3mm x 6.3mm  
and 6.3mm x 16mm.

◆ (KO1630)  
Overall length  
6in (15.2cm).



KLEINERT-RAGNELL  
Retractor  
Double-ended.

◆ (KO1631)  
Overall length  
6in (15.2cm).



KASDEN Thin Blade  
Retractor  
Double-ended.

(KO1632)  
Overall length  
6-1/4in (15.9cm).



BROWNE Retractors  
Overall length  
10-7/8in (27.5cm).

KO1633  
Blades  
40mm x 50mm wide.

(KO1634)  
Blades  
60mm x 65mm wide.



HAYES Hand Retractor  
Distal tip 6mm wide.

(KO1635)  
Overall length  
6in (15.2cm).



HOHMANN Retractor  
Blade 16mm wide.

(KO1636)  
Overall length  
4-3/4in (12.1cm).



HOHMANN Retractor  
Blade 15mm wide.

(KO1637)  
Overall length  
6in (15.2cm).



HOHMANN Retractors  
Short tip. Overall length  
6-1/4in (15.9cm).

KO1638  
Blade 6mm wide.

(KO1639)  
Blade 8mm wide.



**HOHMANN Retractor**  
Overall length  
6-1/2in (16.5cm).

KO1640

Blade 15mm wide.



**HOHMANN Retractors**  
Overall length  
8-3/4in (22.2cm).

KO1641

Blade 8mm wide.

KO1642  
Blade 10mm wide.



**HOHMANN Retractor**  
Overall length  
10-3/4in (27.3cm).

◆ KO1643

Blade 24mm wide.



**HOHMANN Retractor**  
Blade 22mm wide.  
Curved 120°.

KO1644

Overall length  
16in (40.6cm).



**HOHMANN Retractors**

◆ KO1645  
Blade 18mm wide.  
Overall length  
9-1/4in (23.5cm).

KO1646  
Blade 44mm wide.  
Overall length  
9-1/2in (24.1cm).

KO1647  
Blade 70mm wide.  
Overall length  
9-1/2in (24.1cm).



**HOHMANN Retractor**  
Blade 40mm wide.  
Curved 90°.

KO1648

Overall length  
13in (33cm).

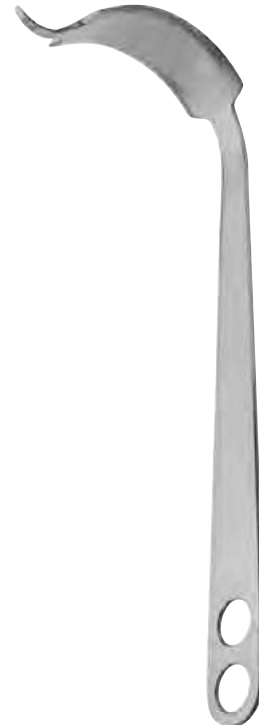

**BRISTOW-BANKART Soft Tissue Retractor**  
Blade 2.1cm wide.

KO1649

Overall length  
8-3/4in (22.2cm).



**Pelvic Retractor**  
Single prong.  
Blade 24mm wide.

KO1650

Overall length  
10-3/4in (27.3cm).



**AUFRANC Cobra Retractors**  
Hollow handle. Maximum blade width  
1-1/4in (3.2cm).  
Overall length  
10in (25.4cm).



KO1651

Smooth blunt tip.



KO1652

Smooth pointed tip.

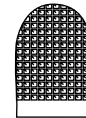

KO1653

Serrated blunt tip.



**DOANE Knee Retractors**  
Double-ended.

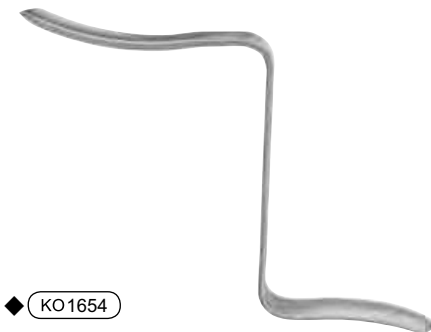

KO1654

Medium.  
Blade 5.7cm and 7.5cm deep,  
15.2cm long, 1.1cm wide.

KO1655

Large.  
Blade 6.6cm and 8cm deep,  
15.2cm long, 1.1cm wide.

**MORREY Elbow Retractors**  
Double-ended.

KO1656

Set includes 1 each  
OS3500-001 (large/medium)  
and OS3500-002  
(small/medium).

KO1657

Large/Medium.  
Overall length  
12.5in (31cm).

KO1658

Small/Medium.  
Overall length  
11in (27.5cm).



**BRISTOW-BANKART Humeral Retractor**



KO1659

Blade 2.5cm wide, 10.2cm deep.

**Ligament Retractors**

KO1660

Medium.  
Overall length  
11-1/2in (29cm).

KO1661  
Long.  
Overall length  
15in (38cm).



**CHANDLER Retractors**

Overall  
length  
8-1/2in  
(21.5cm).

KO1662  
Blade 15.9mm wide.

KO1663  
Blade 19.1mm wide.



**Humeral Head  
Retractor**

KO1664

Overall length  
8-1/2in (21.6cm).



**MURPHY-LANE Bone  
Skid**

KO1665

Overall length  
12in (30.5cm).



**BENNETT Bone Elevators  
and Retractors**

Overall  
length  
9-3/4in  
(24.8cm).

KO440

Small blade.  
Blade 1-3/4in  
(44mm) wide.

KO440  
Large blade.  
Blade 2-1/2in  
(64mm) wide.



**BLOUNT Retractor**

Overall length 10-1/2in (26.7cm).

KO440

Double prong.  
Blade 44mm wide.



**BLOUNT Retractor**

Overall length  
10-1/2in (26.7cm).

KO440

Single prong.  
Blade 37mm wide.



**BLOUNT Knee Retractor**

Overall length 7in (17.8cm).

KO440

6mm tip.





**SMILLIE Knee Retractor**  
Overall length 5-1/2in (14cm).

KO1666  
Straight.  
Blade 19mm x 30mm wide.

KO1667  
Straight.  
Blade 19mm x 45mm wide.

KO1668  
Straight.  
Blade 19mm x 60mm wide.

KO1669  
Curved.  
Blade 13mm x 18mm wide.

**KO1670**  
Reverse curve.  
Blade 13mm x 55mm wide.



**Angulated T-Handle Retractors**  
5in (12.7cm) deep blade.

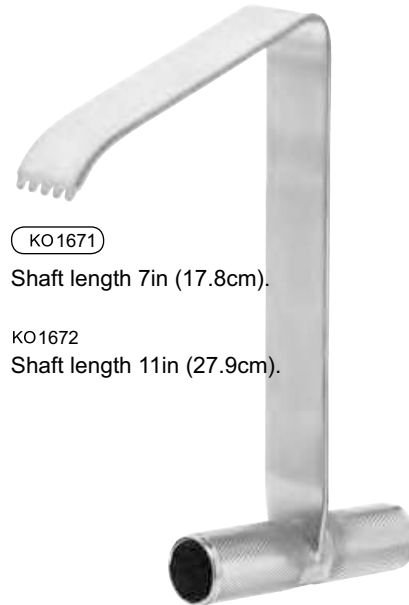

**KO1671**  
Shaft length 7in (17.8cm).

KO1672  
Shaft length 11in (27.9cm).

**T-Handle Bone Hook**  
Overall length 7in (17.8cm).

**KO1673**  
Sharp.



**FUKUDA-STYLE Shoulder Retractors**  
Overall length 7in (17.8cm).  
Blade 32mm x 81mm wide.

KO1673  
Straight.

KO1674  
Slight curve.

**KO1675**  
Full curve.

KO1676  
Reverse curve.



**Capsule Retractors**  
Overall length 10in (25.4cm).

KO1677  
1 prong. 20mm wide.

KO1678  
2 prongs. 20mm wide.

**KO1679**  
3 prongs. 22mm wide.



*Looking for a specific product?*

When you know the catalog number or the name of the product you need, you can use the index at the end of this book to direct you to the page on which the product is described. If you do not find the specific instruments you are looking for, please contact your local V. Mueller sales representative.

**SOFIELD Retractor**  
Double-ended. Mirror and Satin finish.

KO1680  
Set of 6 with clip.  
Includes 1 each of the following sizes:

Part No.	Description
KO1681	Blade length 6.3cm x 1.3cm and 3.8cm x 1.3cm
KO1682	Blade length 7cm x 1.3cm and 4.4cm x 1.3cm
<b>KO1683</b>	Blade length 8.3cm x 1.6cm and 5.1cm x 1.6cm
KO1684	Blade length 8.9cm x 1.6cm and 5.7cm x 1.6cm
KO1685	Blade length 10.2cm x 1.9cm and 7cm x 1.9cm
KO1686	Blade length 11.4cm x 1.9cm and 7.6cm x 1.9cm

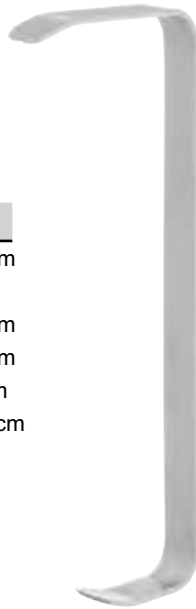

**CLOWARD-Style Muscle Retractor**  
Short blade.

**KO1687**

Overall length 7-3/4in (19.7cm).  
6.4mm x 9.5mm.



**CLOWARD-Style Blade Retractors**  
Overall length 7in (17.8cm).

KO1688  
Blade 13mm x 70mm wide.

KO1689  
Without lip. Blade 13mm x 70mm wide.

KO1690  
Blade 18mm x 75mm wide.

KO1691  
Without lip. Blade 18mm x 75mm wide.

KO1692  
Blade 20mm wide x 75mm wide.

**KO1693**  
Without lip. Blade 20mm x 75mm wide.

KO1694  
Blade 23mm wide x 75mm wide.

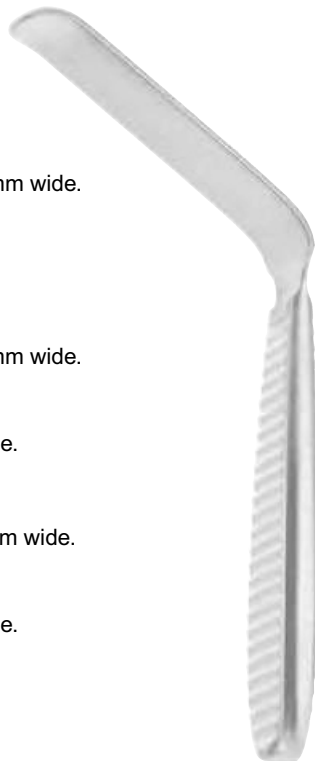

**CLOWARD-Style Blade Retractors**  
Overall length 7-1/2in (19.1cm).

**KO1695**

Blade 13mm x 70mm wide.

KO1696  
Without lip. Blade 18mm x 75mm wide.

KO1697  
Without lip. Blade 20mm x 75mm wide.

KO1698  
Blade 23mm x 75mm wide.

KO1699  
Without lip. Blade 23mm x 75mm wide.

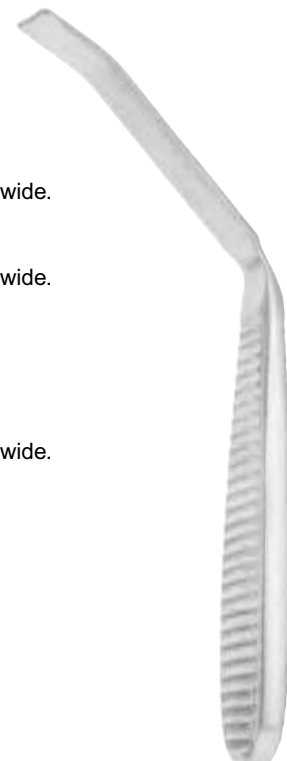

NEURO/SPINE  
AND ORTHOPEDIC

**HIBBS Retractors**  
Overall length 9-1/8in (23.2cm).

KO1700

Blade 1in x 3in (2.5cm x 7.6cm) wide.

KO1701

Blade 3/4in x 2in (1.9cm x 5.1cm) wide.

KO1702

Blade 1/2in x 1in (1.3cm x 2.5cm) wide.

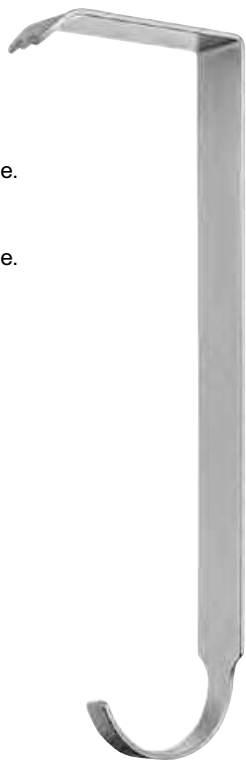

**MEYERDING Retractors**  
Sharp-toothed edge holds tissue for fullest exposure.

KO1703

Blade 2in x 3-1/2in  
(5.1cm x 8.9cm) wide.  
Overall length  
9-1/2in (24.1cm).

◆ KO1704

Blade 1in x 3in  
(2.5cm x 7.6cm) wide.  
Overall length  
9-1/4in (23.5cm).

KO1705

Blade 5/8in x 2in  
(1.6cm x 5.1cm) wide.  
Overall length  
8-1/2in (21.6cm).



**COLLIS TAYLOR Retractors**  
Regular width. 3.2cm wide. Overall length 7-1/4in (18.4cm).

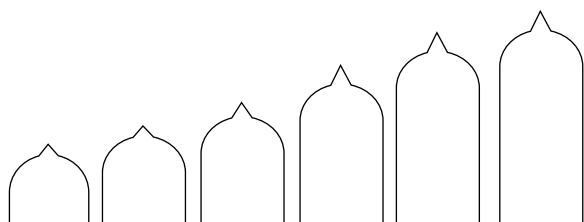

KO1706

Set of 6 blade lengths with sterilizing case.  
Includes 1 each of the following:

Part No.	Description
KO1707	Blade length 1-1/2in (3.8cm).
KO1708	Blade length 2in (5.2cm).
KO1709	Blade length 2-1/2in (6.5cm).
KO1710	Blade length 3in (7.6cm).
KO1711	Blade length 3-1/2in (8.9cm).
KO1712	Blade length 4in (10.2cm).
KO1713	Sterilizing case.

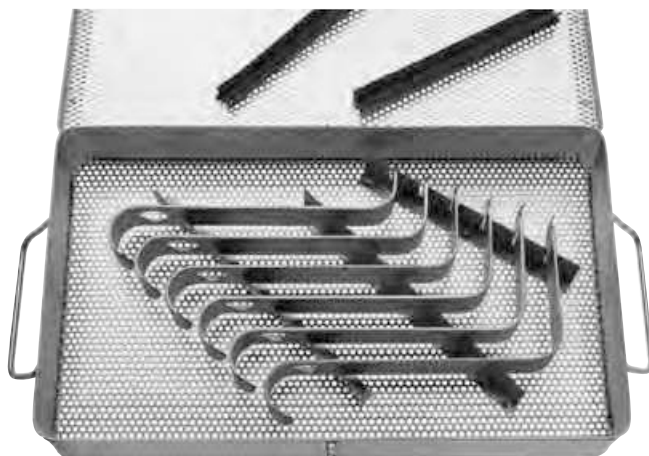

**COLLIS TAYLOR Retractors**

Micro width. 3.1cm wide. Overall length 7-1/4in (18.4cm).

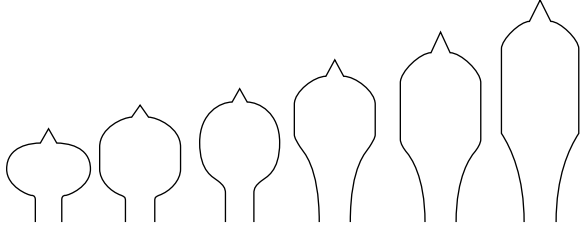

KO1714

Set of 6 blade lengths with sterilizing case.  
Includes 1 each of the following:

Part No.	Description
KO1715	Blade length 1-1/2in (3.8cm).
KO1716	Blade length 2in (5.1cm).
KO1717	Blade length 2-1/2in (6.4cm).
KO1718	Blade length 3in (7.6cm).
KO1719	Blade length 3-1/2in (8.9cm).
KO1720	Blade length 4in (10.2cm).
KO1721	Sterilizing Case.

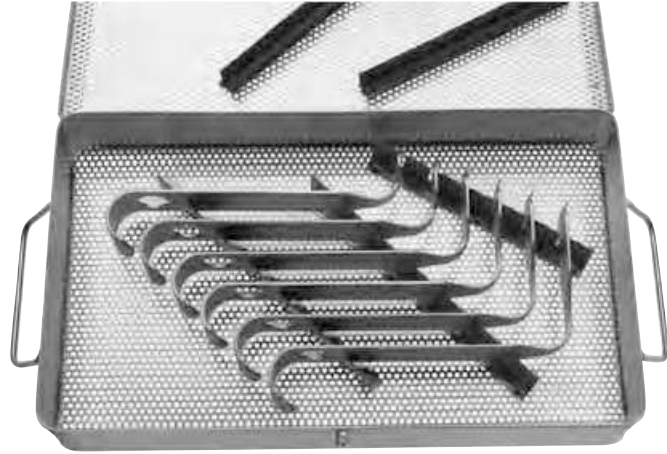

**COLLIS TAYLOR Retractors**

Narrow width. 2.2cm wide. Overall length 7-1/4in (18.4cm).

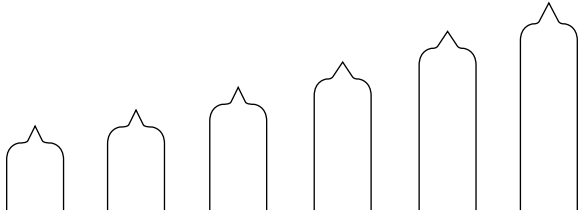

KO1722

Set of 6 blade lengths with sterilizing case.  
Includes 1 each of the following:

Part No.	Description
KO1723	Blade length 1-1/2in (3.8cm).
KO1724	Blade length 2in (5.1cm).
KO1725	Blade length 2-1/2in (6.4cm).
KO1726	Blade length 3in (7.6cm).
KO1727	Blade length 3-1/2in (8.9cm).
KO1728	Blade length 4in (10.2cm).
KO1729	Sterilizing case.

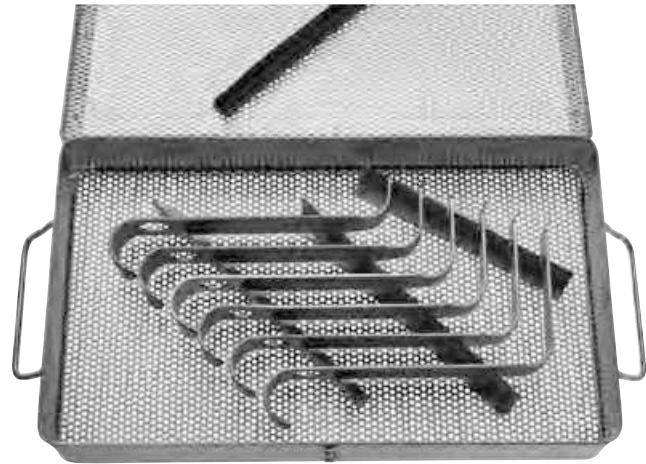

**SELETZ-GELPI Retractor**  
Modified, with long curve in shanks.  
Ratchet lock.

◆ **KO1629**

Overall length  
7in (17.8cm).



**ZELPI-Type Retractors**  
Angled 90°. 5in (12.7cm) maximum spread.  
Overall length 10-1/4in (26cm).

**KO1630**

3in (7.6cm) deep arms.

**KO1631**

4in (10.2cm) deep arms.

**KO1632**

5in (12.7cm) deep arms.



**BECKMAN Retractors**  
Hinged arms. 3 x 4 prongs.

**KO1633**

Blunt.  
Overall length  
5-1/2in (14cm).

**KO1634**

Blunt.  
Overall length  
6-1/2in (16.5cm).

**KO1635**

Sharp.  
Overall length  
5-1/2in (14cm).

**KO1636**

Sharp.  
Overall length  
8-1/2in (21.6cm).



#### *V. Mueller Instrument Detergents*

To assist with the care and handling of your instruments, CareFusion offers you a full line of cleaning and decontamination products detailed in the Genesis Sterilization Containers and Instrument Processing Supplies section of this armamentarium.

### Initial Incision Retractor Set

KO1637

Set includes two 2in (5cm) blades, frame, and 3lb weight with chain.

- KO1638 Short blades. (2 each)
- KO1639 Frame. (1 each)
- KO1640 3lb weight on chain. (1 each)

### Large Initial Self-Retaining Retractor

KO1641  
Frame 7-1/2in x 10-1/2in (19cm x 26.5cm).  
Adjustable blades 2.5cm x 2.5cm.  
Weight 3 lb.

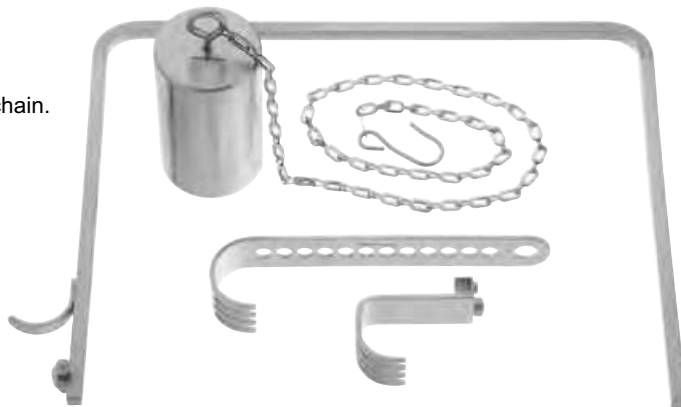

### Incision Retractor Set Components

- KO1646 Frame only. 7-1/2in x 10-1/2in (19cm x 26.5cm).
- KO1647 3lb weight on chain.
- KO1648 Chain.

### Deep Initial Incision Retractor Set

KO1642  
Set includes two 4in (10.2cm) blades, frame, and 3lb.  
KO1643 Long blades. (2 each)  
KO1644 Frame. (1 each)  
KO1645 3lb weight on chain. (1 each)

### Incision Retractor Blade Set

KO1649

Deep blades.  
Includes two  
4in (10.2cm) blades.

KO1950  
Includes two  
2in (5.12cm) blades.



### Short Incision Blades Single blade only.

- KO1951 1in x 1in (2.5cm x 2.5cm).
- KO1950 1in x 1-1/2in (2.5cm x 3.8cm).
- KO1952 1in x 2in (2.5cm x 5.0cm).
- KO1953 1in x 2-1/4in (2.5cm x 5.7cm).
- KO1954 1in x 2-1/2in (2.5cm x 6.3cm).
- KO1955 1in x 3in (2.5cm x 7.5cm).
- KO1956 1in x 4in (2.5cm x 10.0cm).
- KO1957 1in x 5in (2.5cm x 12.7cm).





---

**Long Incision Blades**  
Single blade only.

KO1958  
1in x 1in (2.5cm x 2.5cm).

KO1959  
1in x 1-1/2in (2.5cm x 3.8cm).

KO1960  
1in x 2in (2.5cm x 5.0cm).

KO1961  
1in x 2-1/4in (2.5cm x 5.7cm).

KO1962  
1in x 2-1/2in (2.5cm x 6.3cm).

KO1963  
1in x 3in (2.5cm x 7.5cm).

KO1964  
1in x 4in (2.5cm x 10.0cm).

KO1965  
1in x 4-1/2in (2.5cm x 11.4cm).

**KO1966**  
1in x 5in (2.5cm x 12.7cm).



---

**BOYES-GOODFELLOW Hook**  
Modified points.

**KO1967**  
Overall length  
8-1/4in (21cm).



---

**Customer Support**

Our highly trained, centralized V. Mueller customer support team is available to take your calls from 7:00 a.m. to 6:00 p.m. (CST), M-F. This group is dedicated to providing a full range of support services, including:

- Order placement
- Order inquiries
- Delivery information
- Product information
- Pricing inquiries



Bone Hooks  
Heavy model.  
Overall length 9in (22.9cm).

KO1968

Sharp.  
Hook diameter 3/4in (1.9cm).

KO1969  
Blunt.  
Hook diameter 3/4in (1.9cm).

KO1670  
Sharp.  
Hook diameter 1in (2.5cm).

KO1671  
Sharp.  
Hook diameter 1-3/16in (3cm).



GILLIES Bone and Zygoma Hook  
Diameter 9mm.

KO1672

Overall length 7-3/8in (18.7cm).



Lead Hands  
Malleable.

KO1673

Small.

◆ KO1674  
Large.



Lead Hand  
Malleable.  
Made with Tin.

◆ KO1675

Overall length 12in (30.5cm).



LEWIN Spinal Perforating Forceps  
Jaws extend from shanks in curve.

◆ KO1676

Overall length 7in (17.8cm).



CHANDLER Spinal Perforating Forceps  
Jaws extend in line with shanks.

KO1677

Overall length 7in (17.8cm).



**KERN Bone Holding Forceps**

KO1678  
With folding ratchet.  
Small. Overall length  
5-1/2in (14cm).

KO1679  
With folding ratchet.  
Overall length  
8-1/2in (21.6cm).

KO1680  
Without ratchet.  
Overall length  
5-3/4in (14.6cm).



**LANE Bone Holding Forceps**

KO1681  
With ratchet.  
Overall length  
13in (33cm).

KO1682  
With ratchet.  
Heavy model.  
Overall length  
13in (33cm).

KO1683  
With ratchet.  
Overall length  
17in (43.2cm).

KO1684  
Without ratchet.  
Light model.  
Overall length  
13in (33cm).

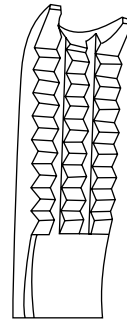

KO1685  
Without ratchet.  
Heavy model.  
Overall length  
13in (33cm).

KO1686  
Without ratchet.  
Overall length  
17in (43.2cm).



**LAMBOTTE Bone Holding Forceps**  
Adjustable.

KO1687  
Overall length  
8-1/2in (21.6cm).



**FARABEUF-LAMBOTTE Bone Holding Forceps**  
Adjustable.

KO1688  
Overall length  
10in (25.4cm).



**BISHOP Bone Holding Forceps**  
Adjustable.

KO1689  
Overall length  
9in (23cm).



**Bone Forceps**  
Self-centering. Extra-small serrated jaw, length 10mm.

KO1690  
Size 0.  
Overall length  
6-3/4in (17.1cm).



**ULRICH Bone Holding Forceps**  
Quick-speed positive locking nut for easy adjustment.

KO1691  
Small size.  
Overall length  
8-3/4in (22.2cm).  
KO1692  
Medium size.  
Overall length  
9-1/2in (24.1cm).



**ULRICH Small Bone Holding Forceps**  
Self-retaining. Dual locking nuts prevent further closing of jaws after tightening. Narrow, straight style.

KO1693  
Overall length  
7-1/4in (18.4cm).



**ULRICH Bone Holding Forceps**  
1 serrated jaw swiveled, the other a double prong.

KO1694  
Overall length  
9-1/2in (24.1cm).



**LOWMAN Bone Holding Clamps**  
1 x 2 prong jaws.

KO1695  
Small size.  
Overall length  
4-3/4in (12.1cm).  
KO1696  
Medium size.  
Overall length  
7in (17.8cm).  
KO1697  
Large size.  
Overall length  
8-1/4in (20.8cm).



For more than 115 years, the V. Mueller® name has been known worldwide as a leading developer, manufacturer and provider of high-quality surgical instruments. As part of CareFusion, V. Mueller® instrumentation continues to offer innovative surgical instruments, including a broad selection of laparoscopic instruments to satisfy your minimally invasive surgical instrument needs.

NEURO/SPINE  
AND ORTHOPEDIC

LAMBERT-LOWMAN Bone Clamp  
2 x 2 jaws, 1-3/8in (3.5cm) wide.

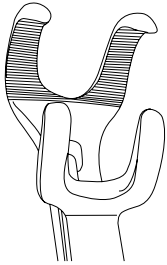

KO1698

Overall length  
8in (20.3cm).



DINGMAN Bone Holding Forceps  
Overall length  
7-1/4in (18.4cm).

KO1699

Small,  
narrow jaws.

KO1700  
Large jaws.



DINGMAN Bone Holding Forceps  
Large jaws.  
Slot in 1 jaw  
0.3cm wide.

KO1701

Overall length  
7-1/4in (18.4cm).



LANGENBECK Bone Holding  
Forceps  
2 x 2 teeth.

KO1702

Overall length  
8-1/4in (21cm).



FERGUSON Bone Holding Forceps

KO1703

Overall length  
8-1/4in (21cm).



FARABEUZ Bone Holding Forceps  
Adjustable.

KO1704

Overall length  
10-1/2in (26.7cm).



VERBRUGGE Bone Holding Forceps  
Ratchet.

KO1705

Overall length  
6-3/4in (17.1cm).



VERBRUGGE Bone Holding Forceps  
Speed lock.

KO1706  
Overall length  
6in (15.2cm).

KO1707  
Overall length  
9-1/2in (24.1cm).

◆ KO1708

Overall length  
10in (25.4cm).

KO1709  
Overall length  
11in (27.9cm).

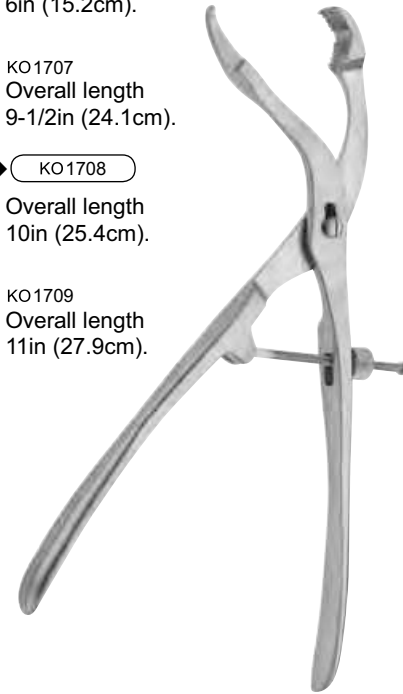

VERBRUGGE Bone Holding Forceps  
Long ratchet.

KO1710

Overall length  
10in (25.4cm).

KO1711  
Overall length  
10-1/2in (26.7cm).

KO1712  
Overall length  
11in (27.9cm).



LOCKE Phalangeal Forceps  
1 x 2 teeth. Serrated.



KO1713

Overall length  
6in (15.2cm).



Small Bone Clamp  
Slight curve.

KO1714

Overall length  
6-1/2in (16.5cm).



Fibula Forceps  
Speed lock.

KO1715

Overall length  
8-1/4in (21cm).



PATELLA Forceps  
Speed lock.

KO1716

Overall length  
7-1/4in (18.4cm).



Reduction Forceps

KO1717

Ratchet.  
Serrated jaw.  
Overall length  
5-1/2in (14cm).

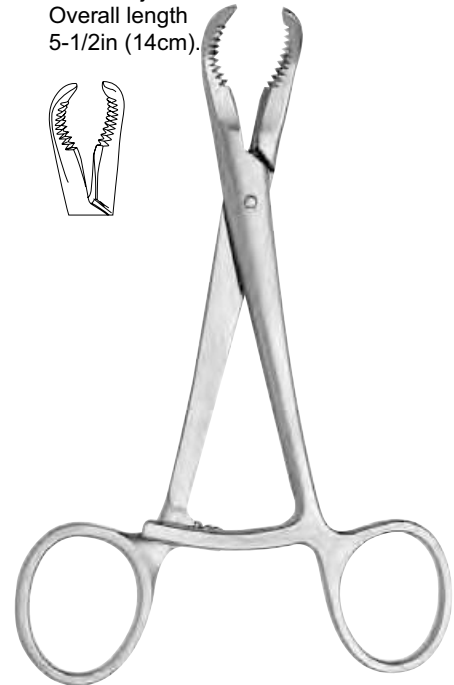

Bone Reduction Forceps

KO1718

Ratchet.  
Pointed jaw with step.  
Overall length  
6-3/4in (17.1cm).

KO1719  
Ratchet.  
Pointed jaw.  
Overall length  
8in (20.3cm).

KO1720  
Speed lock.  
Pointed jaw.  
Overall length  
8in (20.3cm).

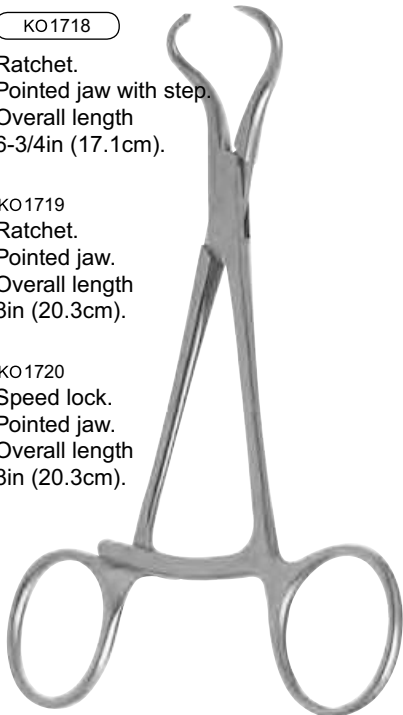

Bone Reduction Forceps  
Ratchet. Serrated with pointed jaw.

KO1721

Overall length  
5in (12.7cm).

KO1722  
Overall length  
5-1/2in (14cm).



Bone Reduction Forceps  
Ratchet. Pointed jaw.

KO1723

Overall length  
7in (17.8cm).





Bone Reduction Forceps

◆ KO1724

Ratchet. Pointed jaw.  
Overall length  
8in (20.3cm).



Reduction Forceps

KO1725

Small serrated jaw.  
Overall length  
7in (17.8cm).

◆ KO1726  
Large serrated jaw.  
Overall length  
9in (23cm).



Pelvic Reduction Forceps

KO1727

1 x 2 jaws.  
Overall length  
16in (40.6cm).



Pelvic Reduction Forceps

KO1728

Overall length  
10in (25.4cm).

KO1729  
Overall length  
16in (40.6cm).



Pelvic Reduction Forceps  
Asymmetric.

KO1730

Overall length  
16in (40.6cm).



Metatarsal Elevators  
Overall length 6-1/2in (16.5cm).

KO1731

Blade 11mm wide.

KO1732  
Blade 13mm wide.

KO1733  
Blade 15mm wide.

KO1734  
Blade 17mm wide.





**MOLT Elevator**  
Double-ended.  
Slightly curved,  
round end.

KO1735

Overall length  
7in (17.8cm).



**CUSHING Elevator**  
Small. Blunt blade,  
6mm wide.

KO1736

Overall length  
7-1/4in (18.4cm).



**CUSHING Elevator**  
Narrow. Sharp blade,  
8mm wide.

KO1737

Overall length  
7-3/4in (19.7cm).



**CUSHING Elevators**  
Wide, sharp end.  
Overall length  
7-1/2in (19.1cm).

KO1738

Round edge.  
Overall length  
7-1/2in (19.1cm).



KO1739  
Round edge  
on "S" curved shank.  
Overall length  
7-1/2in (19.1cm).

KO1740  
Square edge.  
Overall length  
7-1/2in (19.1cm).

**CUSHING Elevator**  
Wide, sharp.  
Blade 15mm wide.

KO1741

Overall length  
7-1/2in (19.1cm).



**CUSHING**  
Staphylorrhaphy  
Elevator  
Blade 6mm wide.

KO1742

Overall length  
8in (20.3cm).



**WOODSON Dural**  
Separator and Packer  
Double-ended.  
Blade 13mm x  
3mm wide.

KO1743

Overall length  
6-3/4in (17.1cm).



**WOODSON Elevator**  
and Spatula  
Double-ended.

KO1744  
Overall length  
7in (17.8cm).

KO1745

With groove.  
Overall length  
7in (17.8cm).

KO1746  
Overall length  
10in (25.4cm).



**Excavator and Packer**  
Double-ended.

KO1747

Overall length  
5-3/4in (14.6cm).



**KEY Periosteal Elevators**

KO1748  
1/8in (3.1mm) wide.  
Overall length 6-3/4in (17.1cm).

◆ KO1749

1/4in (6.3mm) wide.  
Overall length 6-7/8in (17.5cm).

KO1750  
3/8in (9.5mm) wide.  
Overall length 7-1/4in (18.4cm).

◆ KO1751

1/2in (12.7mm) wide.  
Overall length 7-1/4in (18.4cm).

KO1752  
5/8in (15.8mm) wide.  
Overall length 7-3/4in (19.7cm).

KO1753  
3/4in (19mm) wide.  
Overall length 8in (20.3cm).

KO1754  
1in (25.4mm) wide.  
Overall length 8-1/4in (21cm).



**ADSON Periosteal Elevator**  
Sharp, square edge.



KO1755

Overall length  
6-1/2in (16.5cm).



**ADSON Periosteal Elevator**  
Curved, blunt end.



KO1756

Overall length  
6-1/2in (16.5cm).



**ADSON Periosteal Elevator**  
Straight, with rounded  
semi-sharp edge.



KO1757

Overall length  
6-1/2in (16.5cm).



**ADSON Periosteal Elevator**  
Curved end, semi-sharp.



KO1758

Overall length  
6-1/2in (16.5cm).



**LOVE-ADSON**  
 Periosteal Elevator  
 Semi-sharp blade,  
 5mm wide.



KO1759  
 Overall length  
 6-1/2in (16.5cm).



**CAMPBELL Periosteal**  
 Elevator  
 Slightly curved blade,  
 16mm wide.  
 Mirror and Satin finish.

(KO1760)  
 Overall length  
 7-1/2in (19cm).



**LANGENBECK**  
 Periosteal Elevator  
 Slightly curved.  
 17mm wide.

(KO1761)  
 Overall length  
 7-1/2in (19cm).



**LANGENBECK**  
 Periosteal Elevator  
 Narrow. 6mm wide.

(KO1762)  
 Overall length  
 8-1/4in (21cm).



**HOEN Periosteal**  
 Elevators

(KO1763)  
 7mm wide.  
 Overall length  
 6-1/4in (15.9cm).

KO1764  
 15mm wide.  
 Overall length  
 7-1/4in (18.4cm).

KO1765  
 20mm wide.  
 Overall length  
 7-1/2in (19.1cm).



**FARABEUF Periosteal**  
 Elevator  
 Double-ended:  
 1 straight, 1 curved.

(KO1766)  
 Overall length  
 7-1/2in (19.1cm).



**SAYRE Double-Ended**  
 Elevators  
 Overall length  
 6-1/2in (16.5cm).

KO1767  
 Sharp.

(KO1768)  
 Blunt.



**CLOWARD-Style**  
 Periosteal Elevators  
 Overall length  
 7-3/4in (19.7cm).

(KO1769)  
 Angled 90°.

KO1770  
 No. 1. Blade  
 5mm wide.

KO1771  
 No. 2. Blade  
 6mm wide.

KO1772  
 No. 3. Blade  
 8mm wide.

KO1773  
 No. 3C. Blade  
 8mm wide.

KO1774  
 No. 4. Blade  
 12mm wide.



**LEWIN Dissector**

KO1775

Overall length  
7-1/2in (19cm).



**CHANDLER Bone Elevators**

KO1776

Small.  
Overall length  
7-1/4in (18.4cm).

KO1777  
Medium.  
Overall length  
8in (20.3cm).

KO1778  
Large.  
Overall length  
9-1/4in (23.5cm).

KO1779  
Extra-large.  
Overall length  
10in (25.4cm).



**CREGO Elevators**  
Overall length  
8in (20.3cm).

KO1780  
Size 1.  
Blade 6.5mm wide.

KO1781  
Size 2.  
Blade 7.1mm wide.

KO1782

Size 3.  
Blade 14.6mm wide.



**COBB Spinal Elevators**  
Hex handle. Overall length  
9-1/2in (24cm).



KO1783  
Blade 3/4in x 3/8in  
(19mm x 10mm) wide.

KO1784

Blade 7/8in x 1/2in  
(22mm x 13mm) wide.

KO1785  
Blade 1-1/4in x 3/4in  
(32mm x 19mm) wide.



**COBB Elevators**  
Hex handle.  
Overall length  
9-1/2in (24cm).

KO1786  
Blade 10mm wide.

KO1787

Blade 13mm wide.

KO1788  
Blade 19mm wide.

KO1789  
Blade 25mm wide.

KO1790  
Blade 32mm wide.



**COBB Spinal Elevators**  
Hollow handle.  
Overall length  
9-1/2in (24.1cm).

KO1791  
Blade 3/8in  
(10mm) wide.

KO1792

Blade 1/2in  
(13mm) wide.

KO1793  
Blade 3/4in  
(19mm) wide.



**COBB-Type Elevators**  
Semi-sharp blade.  
Overall length  
10-1/2in (26.7cm).

KO1794  
13mm wide.

KO1795

19mm wide.



**COBB (DAWSON-YUHL) Elevators**  
Overall length 11in (28cm).

KO1796  
Blade 13mm wide.

KO1797

Blade 19mm wide.

KO1798  
Blade 25mm wide.

KO1799  
Blade 32mm wide.



**DAWSON-YUHL**  
Periosteal Elevator  
Curved. Tip 6mm wide.

KO 1800

Overall length  
11in (27.9cm).



**COBB Periosteal**  
Elevator  
Curved. Tip 13mm wide.

KO 1801

Overall length  
11in (28cm).



**COBB Periosteal**  
Elevators  
Curved. Overall length  
12in (30.5cm).

KO 1802

7mm wide.

KO 1803  
10mm wide.

KO 1804  
17mm wide.



**COBB-Type Elevators**  
Overall length  
14in (35.5cm).

KO 1805

Blade 16mm wide.

KO 1806  
Blade 19mm wide.

KO 1807  
Blade 25mm wide.



**Jumbo Grip Elevators**  
Extra large.  
Overall length  
13-1/4in (33.7cm).

KO 1808

Blade 10mm wide.

KO 1809  
Blade 15mm wide.

KO 1810  
Blade 20mm wide.

KO 1811  
Blade 25mm wide.

KO 1812  
Blade 30mm wide.

KO 1813  
Blade 35mm wide.



**Jumbo Grip Elevators**  
Extra large.  
Working length  
6in (15.2cm).  
Overall length  
15in (38cm).

KO 1814  
Blade 9mm wide.

KO 1815

Blade 13mm wide.

KO 1816  
Blade 19mm wide.

KO 1817  
Blade 25mm wide.

KO 1818  
Blade 32mm wide.



**Periosteal Elevators**  
Phenolic handle.

KO1819  
Slight curve. Straight edge.  
Blade 3mm. Overall length  
7-1/4in (18.4cm).

KO1820  
Slight curve. Straight edge.  
Blade 6mm. Overall length  
7-1/4in (18.4cm).

KO1821  
Strong curve. Straight edge.  
Blade 13mm. Overall length  
7-1/2in (19cm).

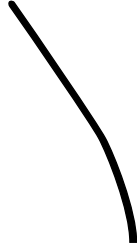

KO1822  
Slight curve. Round edge.  
Blade 6mm. Overall length  
7-1/4in (18.4cm).

KO1823  
Strong curve. Round edge.  
Blade 14mm. Overall length  
7-3/4in (19.7cm).



**Periosteal Elevators**  
Straight. Phenolic handle.

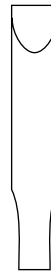

KO1824  
Straight edge.  
Blade 6mm.  
Overall length  
7-1/4in (18.4cm).

KO1825  
Round edge.  
Blade 14mm.  
Overall length  
7-3/4in (19.7cm).

KO1826  
Straight edge.  
Blade 13mm.  
Overall length  
7-1/4in (18.4cm).

KO1827  
Round edge.  
Blade 20mm.  
Overall length  
7-3/4in (19.7cm).



**SPRATT Mastoid Curettes**  
Oval cup. Overall length 6-1/2in (16.5cm).



KO1828  
Size 000. Cup 3.2mm wide.



KO1833  
Size 3. Cup 7mm wide.



KO1829  
Size 00. Cup 3.4mm wide.



KO1834  
Size 4. Cup 8.4mm wide.



KO1830  
Size 0. Cup 3.7mm wide.



KO1835  
Size 5. Cup 8.9mm wide.



KO1831  
Size 1. Cup 4.7mm wide.



KO1836  
Size 6. Cup 10.2mm wide.



KO1832  
Size 2. Cup 5.7mm wide.



**HIBBS Curettes**



KO1837  
Small cup.  
Overall length  
8in (20.3cm).

KO1838  
Small cup.  
Overall length  
10in (25.4cm).



KO1839  
Medium cup.  
Overall length  
8in (20.3cm).



KO1840  
Large cup.  
Overall length  
8in (20.3cm).



**EPSTEIN Currettes**  
Overall length 8in (20.3cm).



KO1841  
Size 000. Cup 2.6mm wide.



KO1842  
Size 00. Cup 2.9mm wide.



KO1843  
Size 0. Cup 3.4mm wide.



**PAPARELLA Curette**  
Straight shaft. Overall length 9-7/8in (25.2cm).



KO1844  
Size 00.  
Oval cup 6mm x 4mm wide. Angled 45°.



Size 0000 3mm	Size 000 3.2mm	Size 00 3.4mm	Size 0 3.7mm	Size 1 4.7mm	Size 2 5.7mm	Size 3 7mm	Size 4 8.4mm	Size 5 8.9mm	Size 6 10.2mm

**BRUNS Currettes**  
Overall length 9in (22.9cm).

Straight	Angled Forward	Reverse Angled	Size	Cup Size
			0000	3mm
KO1845	KO1854	KO1863	000	3.2mm
KO1846	KO1855	KO1864	00	3.4mm
KO1847	KO1856	KO1865	0	3.7mm
KO1848	KO1857	KO1866	1	4.7mm
KO1849	KO1858	KO1867	2	5.7mm
KO1850	KO1859	KO1868	3	7mm
KO1851	KO1860	KO1869	4	8.4mm
KO1852	KO1861	KO1870	5	8.9mm
KO1853	KO1862	KO1871	6	10.2mm





BRUNS Currettes  
Reverse angled 90°.  
Overall length 8in (20.3cm).

KO 1872  
Size 0.

KO1873

Size 2.



BRUNS Currettes  
Overall length 8in (20.3cm).

Straight	Angled	Reverse Angled	Size
KO 1874	KO 1885	OS908-500	00000
KO 1875	KO 1886	OS908-400	0000
KO 1876	KO 1887	OS908-300	000
KO 1877	KO 1888	OS908-200	00
KO 1878	KO 1889	OS908-100	0
KO 1879	KO 1890	OS908-001	1
KO 1880	KO 1891	OS908-002	2
KO 1881	KO 1892	OS908-003	3
KO 1882	KO 1893	OS908-004	4
KO 1883	KO 1894	OS908-005	5
KO 1884	KO 1895	OS908-006	6



BRUNS Currettes  
Overall length 12in (30.5cm).

Straight	Angled	Reverse Angled	Size
OS903-500	KO1896	OS918-500	00000
OS903-400	KO1897	OS918-400	0000
OS903-300	KO1898	OS918-300	000
OS903-200	KO1899	OS918-200	00
OS903-100	KO1900	OS918-100	0
OS903-001	KO1901	OS918-001	1
OS903-002	KO1902	OS918-002	2
OS903-003	KO1903	OS918-003	3
OS903-004	KO1904	OS918-004	4
OS903-005	KO1905	OS918-005	5
OS903-006	KO1906	OS918-006	6



BRUNS Currettes  
Angled, knurled handle.  
Overall length 11in (27.9cm).

Part No.	Size
OS907-300	000
OS907-200	00
OS907-100	0
OS907-001	1
OS907-002	2
OS907-003	3
OS907-004	4
OS907-005	5
OS907-006	6



NEUROSPINE  
AND ORTHOPEDIC

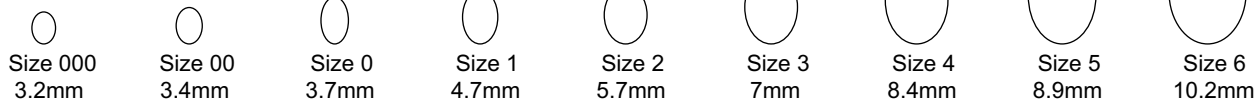

**BRUNS Currettes**  
 Straight. Hexagonal handle.  
 Overall length 9in (22.9cm).

Due to changing surgical trends, some products described in this catalog may be discontinued. Your V. Mueller sales representative may be able to suggest a suitable substitute if one is available.

Part No.	Size	Cup Size
KO1907	000	3.2mm
KO1908	00	3.4mm
KO1909	0	3.7mm
KO1910	1	4.7mm
KO1911	2	5.7mm
KO1912	3	7mm
KO1913	4	8.4mm
KO1914	5	8.9mm
KO1915	6	10.2mm



**Bone Currettes**  
 Straight. Mirror finish.  
 Overall length 9in (22.9cm).

KO1916  
 Bone currettes. Set of 9 sizes.  
 With rack (KO1917).

Part No.	Size	Cup Size
KO1918	000	3.2mm
KO1919	00	3.4mm
KO1920	0	3.7mm
KO1921	1	4.7mm
KO1922	2	5.7mm
KO1923	3	7mm
KO1924	4	8.4mm
KO1925	5	8.9mm
KO1926	6	10.2mm



**Bone Currettes**  
 Straight. Mirror finish.  
 Overall length 11-1/2in (29.2cm).

Part No.	Size	Cup Size
KO1927	000	3.4mm
KO1928	00	3.4mm
KO1929	0	3.7mm
KO1930	1	4.7mm
KO1931	2	5.7mm
KO1932	3	7mm
KO1933	4	8.4mm
KO1934	5	8.9mm
KO1935	6	10.2mm



Curette Sterilization and Storage Rack

**KO1936**

For 9in and 10in (25.4cm) curettes.



MOE Bone Curettes

Straight.  
Overall length 10in (25.4cm).

Part No.	Size	Cup Size
<b>KO1937</b>	00	3.4mm
KO1938	0	3.7mm
KO1939	1	4.7mm
KO1940	2	5.7mm
KO1941	3	7mm
KO1942	4	8.4mm
KO1943	5	8.9mm



COBB (DAWSON-YUHL) Curettes

Overall length 11in (28cm).

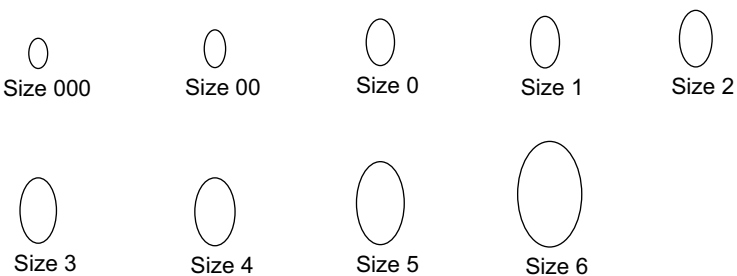

Straight	Angled Forward	Size	Cup Size
KO 1944	NL7106-001	000	2.3mm
KO 1945	NL7106-002	00	2.9mm
KO 1946	NL7106-003	0	3.5mm
KO 1947	NL7106-004	1	4mm
KO 1948	NL7106-005	2	4.4mm
KO 1949	NL7106-006	3	4.8mm
<b>KO 1950</b>	NL7106-007	4	5mm
KO 1951	NL7106-008	5	6.25mm
KO 1952	NL7106-009	6	8mm



COBB Curettes

Overall length 10in (25.4cm).

**KO 1953**  
Size 00, 4.5mm cup.

**KO 1954**  
Size 0, 5mm cup.



NEURO/SPINE  
AND ORTHOPEDIC

DAWSON-YUHL Curette  
Bent backwards. Cup 4mm x 8mm.



KO1955

Overall length  
11in (27.9cm).



Jumbo Grip Cup Crettes  
Extra large. Working length 4-3/4in (12.1cm).  
Overall length 13-1/4in (33.7cm).

Straight	Angled	Reverse Angled	Size	Cup Size
OS990-300	NL6761-300	OS999-300	3-0	
OS990-200	NL6761-200	OS999-200	2-0	
OS990-100	NL6761-100	OS999-100	1-0	
OS990-001	NL6761-001	OS999-001	1	
OS990-002	NL6761-002	OS999-002	2	7mm
OS990-003	NL6761-003	OS999-003	3	9mm
OS990-004	NL6761-004	OS999-004	4	11mm
OS990-005	NL6761-005	OS999-005	5	13mm
OS990-006	NL6761-006	OS999-006	6	15mm
OS990-007	NL6761-007	OS999-007	7	17mm



COLLIS® Cup Curette  
Overall length 11in (28cm).



KO1955

Size 0.



Jumbo Grip Crettes  
Extra large. Overall length 15in (38cm).

Straight	Angled	Reverse Angled	Size	Cup Size
OS986-300		OS987-300	3-0	
OS986-200	KO440	OS987-200	2-0	
OS986-100	KO440	OS987-100	1-0	
OS986-001	KO440	OS987-001	1	
OS986-002	KO440	OS987-002	2	7mm
OS986-003	KO440	OS987-003	3	9mm
OS986-004	KO440	OS987-004	4	11mm
OS986-005	KO440	OS987-005	5	13mm
OS986-006	KO440	OS987-006	6	15mm
OS986-007	KO440	OS987-007	7	17mm



**LAMBOTTE Mini Osteotomes**  
Straight. Overall length 5in (12.7cm).

Straight	Curved	Blade Width
KO 1956	KO 1964	2mm
KO 1957	KO 1965	4mm
KO 1958	KO 1966	6mm
KO 1959	KO 1967	8mm
KO 1960	KO 1968	10mm
KO 1961	KO 1969	12mm
KO 1962	KO 1970	14mm
KO 1963	KO 1971	15mm
		18mm
		19mm
		20mm



**LAMBOTTE Osteotomes**  
Straight. Overall length 6-3/4in (17.1cm).

- KO1972  
Blade 4mm wide.
- KO1973  
Blade 6mm wide.
- KO1974  
Blade 8mm wide.
- KO1975  
Blade 10mm wide.
- KO1976  
Blade 12mm wide.



**LAMBOTTE Osteotome**  
Curved. Overall length 6-3/4in (17cm).

- KO1977  
Blade 3/8in (10mm) wide.



1980

**Small Osteotomes**  
Overall length 7-1/4in (18.5cm).

KO1978  
Set includes 8 osteotomes and 1 mallet.

- KO1979  
Straight. Blade 22mm wide.
- KO1980  
Straight. Blade 16mm wide.
- KO1981  
Straight. Blade 12mm wide.
- KO1982  
Straight. Blade 10mm wide.
- KO1983  
Straight. Blade 8mm wide.
- KO1984  
Curved. Blade 7mm wide.
- KO1985  
Straight. Blade 6mm wide.
- KO1986  
Straight. Blade 4mm wide.
- KO1987  
Mallet. Head diameter 1in (2.5cm). Weight 8oz.



**LAMBOTTE Osteotomes**  
Straight. Overall length 9in (23cm).

- KO1988  
Set of 6.
- KO1989  
Blade 1/4in (6mm) wide.
- KO1990  
Blade 1/2in (13mm) wide.
- KO1991  
Blade 3/4in (19mm) wide.
- KO1992  
Blade 1in (25mm) wide.
- KO1993  
Blade 1-1/4in (32mm) wide.
- KO1994  
Blade 1-1/2in (38mm) wide.



**LAMBOTTE Osteotomes**  
Curved. Overall length 9in (23cm).

- KO1995  
Set of 6.
- KO1996  
Blade 1/4in (6mm) wide.
- KO1997  
Blade 1/2in (13mm) wide.
- KO1998  
Blade 3/4in (19mm) wide.
- KO2000  
Blade 1in (25mm) wide.
- KO2001  
Blade 1-1/4in (32mm) wide.
- KO2002  
Blade 1-1/2in (38mm) wide.



Osteotome Sterilization and Storage Rack  
 For 9in (23cm) LAMBOTTE osteotomes.  
 Holds 12.

◆ KO2003



HOKE Osteotomes  
 Overall length 6in (15.2cm).

Straight	Curved	Blade Width
KO2004	OS4281-005	1/8in (3mm)
KO2005	OS4281-006	3/16in (5mm)
KO2006	OS4281-001	1/4in (6mm)
KO2007	OS4281-009	5/16in (9mm)
KO2008	OS4281-002	3/8in (10mm)
KO2009	OS4281-003	1/2in (13mm)
KO2010	OS4281-004	5/8in (16mm)



U.S. ARMY-Type Osteotomes  
 Overall length  
 6-1/2in (16.5cm).

KO2011

Blade 6mm wide.

KO2012  
 Blade 12mm wide.

KO2013  
 Blade 18mm wide.



CHERRY Osteotome  
 Curved. Blade 4mm wide.

KO2014

Overall length  
 7-3/4in (19.7cm).



CHERRY Osteotomes  
 Straight. 1-piece construction  
 on octagonal handle.  
 Overall length  
 8in (20.3cm).

KO2015

Blade 3mm wide.

KO2016  
 Blade 4mm wide.

KO2017  
 Blade 5mm wide.

KO2018  
 Blade 6mm wide.

KO2019  
 Blade 7mm wide.



**STILLE-Type Osteotomes**  
Overall length  
8in (20.3cm).

- KO2020**  
Blade 10mm wide.
- KO2021**  
Blade 12mm wide.
- KO2022**  
Blade 15mm wide.
- KO2023**  
Blade 20mm wide.



**SMITH-PETERSON Osteotomes**  
Overall length 8-1/4in (21cm).

Straight	Curved	Blade Width
KO2024	OS4182	1/4in (6mm)
KO2025	OS4183	3/8in (9.5mm)
KO2026	OS4184	1/2in (13mm)
KO2027	OS4185	5/8in (16mm)
<b>KO2028</b>	OS4186	3/4in (19mm)
KO2029	OS4188	1in (25mm)
KO2030	OS4189	1-1/2in (38mm)



**SMITH-PETERSEN Storage Rack**  
Holds 7. Storage Racks.

**KO2031**



Instrument sizes, particularly overall lengths, are specified in this catalog as accurately as possible. Slight variations may occur due to metal crafting and finishing operations. Refer to the introductory pages for clarification on measurements. We reserve the right to modify products and/or services depicted herein without customer notice.



**HIBBS Osteotomes**  
Overall length 9-1/2in (24.1cm).

Straight	Curved	Blade Width
KO2032	OS4295-011	1/4in (6mm)
KO2033	OS4295-012	3/8in (9.5mm)
KO2034	OS4295-013	1/2in (13mm)
KO2035	OS4295-014	5/8in (16mm)
KO2036	OS4295-015	3/4in (19mm)
KO2037	OS4295-016	7/8in (22mm)
KO2038	OS4295-017	1in (25mm)
KO2039	OS4295-018	1-1/8in (28mm)
KO2040	OS4295-019	1-1/4in (32mm)
KO2041	OS4295-020	1-1/2in (38mm)



**COBB Osteotomes**  
Overall length 11in (27.9cm).

Straight	Curved	Blade Width
KO2042	OS4331-006	1/4in (6mm)
KO2043	OS4331-010	3/8in (9.5mm)
KO2044	OS4331-013	1/2in (13mm)
KO2045	OS4331-016	5/8in (16mm)
KO2046	OS4331-019	3/4in (19mm)
KO2047	OS4331-025	1in (25mm)
KO2048	OS4331-032	1-1/4in (32mm)



**DAWSON-YUHL Osteotomes**  
Overall length 11in (27.9cm).

- KO2049  
Tip 6.5mm wide.
- KO2050  
Tip 12mm wide.



**HIBBS Chisel Elevator**  
Overall length 7-1/4in (18.5cm).

- KO2051  
5/8in (18mm) wide.



**STILLE-Type Bone Chisels**  
Overall length 8in (20.3cm).

- KO2051  
10mm wide.
- KO2052  
12mm wide.



**HIBBS Bone Chisels**

Overall length 9-1/2in (24.1cm).

Straight	Curved	Blade Width
KO2053	OS4290-011	1/4in (6mm)
KO2054	OS4290-012	3/8in (9.5mm)
KO2055	OS4290-013	1/2in (13mm)
KO2056	OS4290-014	5/8in (16mm)
KO2057	OS4290-015	3/4in (19mm)
KO2058	OS4290-016	7/8in (22mm)
KO2059	OS4290-017	1in (25mm)
KO2060	OS4290-018	1-1/8in (28mm)
KO2061	OS4290-019	1-1/4in (32mm)
KO2062	OS4290-020	1-1/2in (38mm)



**STILLE-Type Bone Gouges**

Overall length 8in (20.3cm).

- KO2064  
12mm wide.
- KO2065  
15mm wide.



**Swan Neck Gouge**  
Hex handle.

- KO2066  
Overall length 9in (22.9cm).



**SMITH-PETERSON Gouges**

Overall length 8in (20.3cm).

Straight	Curved	Blade Width
KO2067	J-0407	1/4in (6mm)
KO2068	J-0408	3/8in (10mm)
KO2069	J-0409	1/2in (13mm)
KO2070	J-0410	5/8in (16mm)
KO2071	J-0411	3/4in (19mm)
KO2072	J-0412	1in (25mm)
KO2073	J-0413	1-1/4in (32mm)



**HIBBS Gouges**

Overall length 9-1/2in (24.1cm).

Straight	Curved	Blade Width
OS4360-001	OS4360-011	1/4in (6mm)
OS4360-002	OS4360-012	3/8in (10mm)
OS4360-003	OS4360-013	1/2in (12mm)
OS4360-004	OS4360-014	5/8in (16mm)
OS4360-005	OS4360-015	3/4in (19mm)
OS4360-006	OS4360-016	7/8in (22mm)
OS4360-007	OS4360-017	1in (25mm)
OS4360-008	OS4360-018	1-1/8in (29mm)
OS4360-009	OS4360-019	1-1/4in (32mm)
OS4360-010	OS4360-020	1-1/2in (38mm)



MOE Gouges  
Straight.  
Overall length  
10in (25.4cm).

KO2074

Wide.

KO2075

Narrow.



COBB Gouge  
Modified style, straight.

KO2076

Overall length  
10-5/8in (27cm).



COBB Gouge  
Bayonet shaped.

KO2077

Overall length  
10-5/8in (27cm).



DAWSON-YUHL Gouge

KO2078

Straight.  
Tip 7mm wide.  
Overall length  
11in (27.9cm).



DAWSON-YUHL Gouge

KO2079

Bayonet.  
Tip 7mm wide.  
Overall length  
11in (27.9cm).



Mallet

Used generally with Osteotomes OS1059-series.  
Head diameter 1in (2.5cm). 1 side stainless steel,  
the other side nylon. Weight 8 oz (227g).

KO2080

Overall length  
7-1/4in (18.5cm).



CRANE Mallet

Short handle. Face 1-3/16in (3cm) diameter.  
Weight 8 oz (227g).

KO2081

Overall length  
6-1/4in (15.9cm).



**GERZOG Mallet**  
Lead filled head.  
Head diameter  
1in (2.5cm). Weight  
14 oz (397.3g).

KO2082

Overall length  
7-1/4 (18.6cm).



**HEATH Mallet**  
Heavyweight. Head diameter 40mm.  
Weight 1 lb, 13 oz (822.7g).

KO2083

Overall length  
7-1/4in (18.4cm).

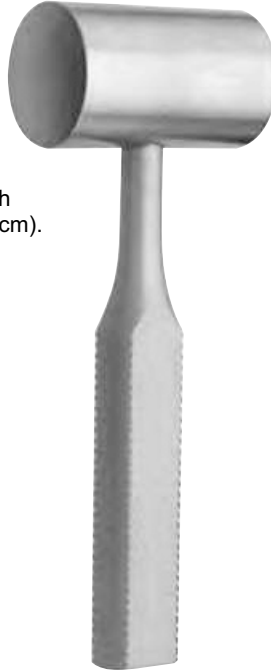

**Orthopaedic Mallets**

KO2084

Head 1-3/16in (3cm)  
diameter. Weight  
1 lb (454g).  
Overall length  
7-3/16in (18.3cm).

KO2085

Head 1-1/2in (3.8cm)  
diameter. Weight  
2 lb (908g).  
Overall length  
7-9/16in (19.3cm).

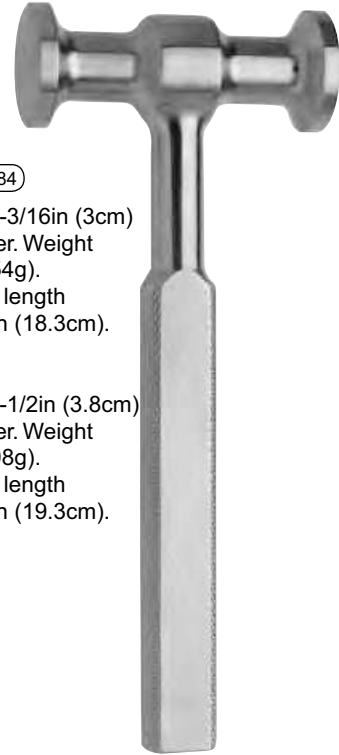

**KIRK Mallet**  
Stainless steel head.  
Head diameter  
1-1/2in (3.8cm).  
Head weight  
26 oz (737.8g).

KO2086

Overall length  
7-3/4in (19.7cm).



**LUCAE Bone Mallet**  
Face 1-1/8in (2.8cm) diameter.  
Weight 11oz (311.3g).  
Mirror and Satin finish.

KO2087

Overall length  
8in (20.3cm).



**MEAD Mallets**  
Head diameter 1in (26mm).  
Weight 11oz (312g).  
Mirror Finish.

KO2088

Overall length  
7-1/2in (19.1cm).

KO2089

Nylon replacement  
caps only.



**BERGMAN Mallet**  
 Weight 11 oz (312g).  
 Aluminum alloy handle.

**KO2090**

Overall length  
 9-1/2in (24.1cm).



**PHENOLIC Handle Mallets**  
 Overall length  
 11in (27.9cm).

**KO2091**

Head diameter 33mm.  
 Weight 1 lb 11 oz (766.1g).

**KO2092**

Head diameter 45mm.  
 Weight 2 lb 9 oz (1163.4g).



**Toronto Bone Mallets**  
 Surface diameter 2-1/4in x 1-7/8in  
 (5.7cm x 4.8cm).  
 Overall length 8in (20.3cm).

**KO2093**

24oz.

**KO2094**  
 30oz.



**CLOWARD-Style Mallets**

**KO2095**  
 19mm face.  
 Overall length  
 7-1/2in (19cm).

**KO2096**

25mm face.  
 Overall length  
 9in (22.9cm).



**CLOWARD-Style Depth Gauge**

**KO2097**

Large.

**KO2098**  
 Small.



**CLOWARD-Style Bone Impactor**  
 Double-ended.

**KO2099**

Overall length  
 8-3/4in (22.2cm).



**Bone Tamps**  
 Cross-serrated tip.  
 Overall length  
 6-1/4in (15.9cm).

**KO3000**

Tip diameter 2mm.

**KO3001**

Tip diameter 3mm.

**KO3002**

Tip diameter 4mm.

**KO3003**

Tip diameter 5mm.



**KO3004**

Tip diameter 6mm.

**KO3005**

Tip diameter 8mm.

**KO3006**

Tip diameter 10mm.



**Bone Impactors**  
 With replaceable nylon caps.  
 Head diameter 20mm.  
 Aluminum.

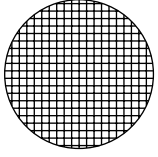

KO3007

Overall length  
 6-1/2in (16.5cm).

KO3008  
 Nylon replacement caps  
 for Bone Impactor OS1612.



**MOE Impactors**  
 Overall length  
 10in (25.4cm).

KO3009

Small.

KO3010  
 Large.



**DAWSON-YUHL Impactor**  
 Tip 12.5mm wide.

KO3011

Overall length  
 11in (27.9cm).



**MILLER Rasp**  
 Double-ended.

KO3012

Overall length  
 7-1/4in (18.4cm).



**FOMAN Rasp**  
 Double-ended.  
 Double-sided.  
 Fine and  
 coarse teeth.  
 Convex and  
 flat blades,  
 8mm wide.

KO3013

Overall length  
 8-1/2in (21.6cm).

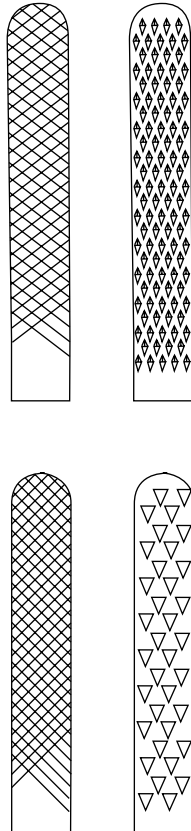

**PUTTI Bone Rasp**  
 Double-ended,  
 with flat,  
 tapering blades;  
 1 blade curved on flat.

KO3014

Overall length  
 10-1/2in (26.7cm).



**PUTTI Bone Rasp**  
Double-ended,  
with 2 tapering blades;  
1 flat, 1 conical.

KO3015

Overall length  
11-3/4in (29.8cm).



**Bone File**  
Bayonet shank.  
Blade 3-1/2in x 1/2in  
(8.9cm x 1.3cm) wide.

KO3016

Overall length  
9in (22.9cm).



**CHARRIERE**  
Amputating Saw  
Chrome  
plated blade,  
8in (20.3cm).

KO3017

Overall length  
11-1/2in (29.2cm).



**SATTERLEE Bone Saw**

KO3018



**LISTON Amputation Knives**

KO3020  
Blade length  
6-3/4in (17.2cm).

KO3019

Blade length  
8in (20.3cm).



**SWEET Amputation Shield**

KO3021





**LISTON Bone Cutting Forceps**  
Straight jaws.

KO3022

Overall length  
5-1/2in (14cm).



**LISTON Bone Cutting Forceps**  
Curved jaws.

KO3023

Overall length  
5-1/2in (14cm).



**LITTAUER-LISTON Bone Cutting Forceps**  
Light, for small bones.

◆ KO3024

Overall length  
5-3/4in (14.6cm).



**HORSLEY Bone Cutting Forceps**  
Straight.

KO3025

Overall length  
7-3/4in (19.7cm).



**KLEINERT-KUTZ Bone Cutting Forceps**  
Double-action.  
Overall length  
5-1/2in (14cm).

◆ KO3026

Straight blades.

KO3027  
Curved blades.

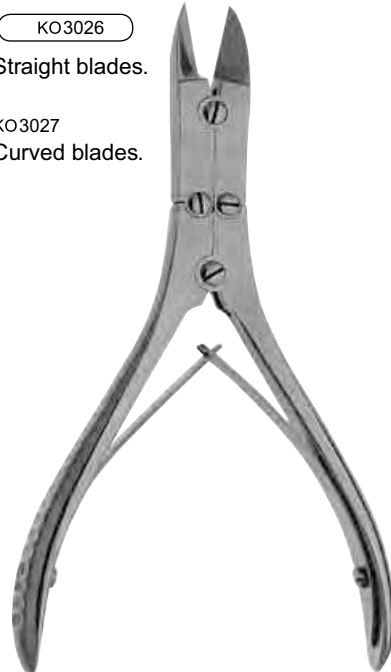

**Bone Cutting Forceps**  
Pointed jaw, length  
3/4in (2cm).

◆ KO3028

Overall length  
5-3/4in (14.6cm).



Bone Cutting Forceps  
Double-action.  
Overall length  
7-1/4in (18.4cm).

◆ (KO3029)

Straight.

KO3030  
Angled up.



RUSKIN Bone Splitting Forceps  
Double-action.  
Overall length  
7-3/8in (18.7cm).

◆ (KO3031)

Straight blades.

KO3032  
Angled blades.



HORSLEY Bone Cutting Forceps  
Double-action with double bend.

◆ (KO3033)

Overall length  
10in (25.4cm).



LISTON-STILLE-Type Bone Cutting  
Forceps  
Double-action bone  
cutting forceps.  
Overall length  
10-1/2in (26.7cm).

◆ (KO3034)

Straight.

KO3035  
Curved.

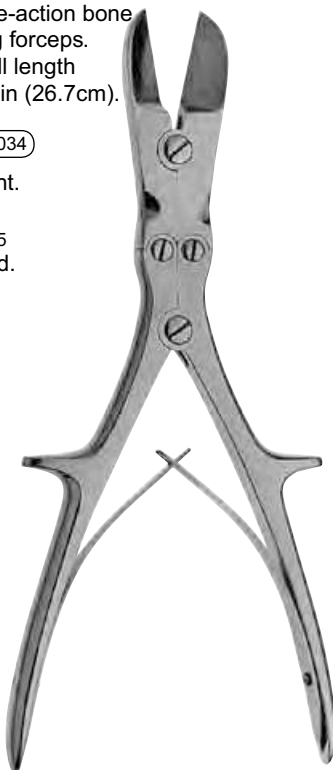

Micro Tissue Rongeurs  
Extra delicate. 2mm x 5mm bite.  
Overall length 7in (17.8cm).

KO3036

Curved.

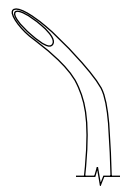

(KO3037)

Strong curve.

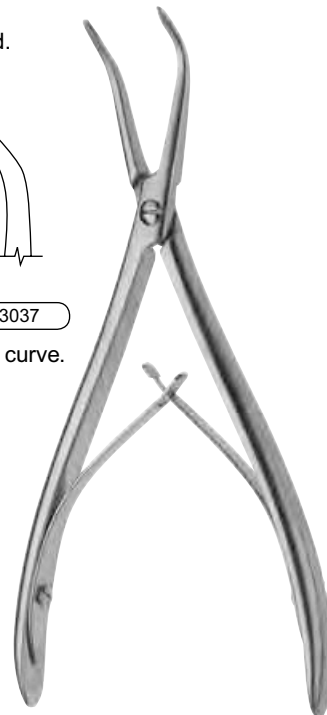

*Custom etching*

Custom etching is available on stainless steel surgical instruments on new orders as they are purchased. Ask your customer support representative at

**FRIEDMANN Taper Jaw Rongeur Forceps**  
Half-curved. Cup 12mm x 3mm wide.



KO3038

Overall length  
5in (12.7cm).



**FRIEDMAN Micro Rongeurs**  
1.3mm x 5mm bite.  
Overall length  
5-1/2in (14cm).

KO3039

Straight.



KO3040

Curved.

KO3041  
Angled 90°.



**ANDREWS-HARTMANN Rongeur Forceps**  
Slightly curved.



KO3041

Overall length  
5-5/8in (14.4cm).



**SHEARER Chicken-Bill Rongeur Forceps**  
Small jaws.

KO3042

Overall length  
5-3/4in (14.5cm).



**Bone Joint Rongeurs**  
Ring handled.

KO3043

Strong curve. Jaws 1mm wide.  
Overall length 5in (12.7cm).

KO3044

Slight curve. Jaws 1.2mm wide.  
Overall length 5-3/4in (14.6cm).

KO3045

Slight curve. Jaws 2mm wide.  
Overall length 5-3/4in (14.6cm).



**LEMPERT Rongeur Forceps**  
Light model with slender jaws.



◆ KO3046

Jaws 7mm x 2.5mm wide.  
Overall length  
7-1/2in (19cm).



KO3047

Jaws 10mm x 2mm wide.  
Overall length  
6-1/2in (16.5cm).



KO3048

Jaws 10mm x 3mm wide.  
Overall length  
9in (22.9cm).



**LUER Rongeur Forceps**  
Cup-shaped jaws, 13mm x 8mm wide.  
Overall length 7in (17.8cm).

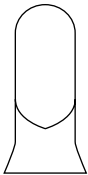

KO3048

Straight.



KO3049

Curved.



**CUSHING Cranial Rongeur Forceps**  
Curved jaws, 11mm x 8.5mm wide.



KO3050

Overall length  
7-1/4in (18.4cm).



ADSON Cranial Rongeur  
Straight. Cup-shaped jaws,  
15mm x 7.5mm wide.

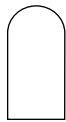

◆ KO3051

Overall length  
8-1/4in (21cm).

KO3052  
Toothed jaws.  
Overall length  
8in (20.3cm).



ADSON Cranial Rongeur Forceps  
Angular cup-shaped jaws,  
14mm x 7.7mm wide.

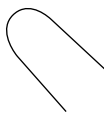

◆ KO3053

Overall length  
8-1/4in (21cm).

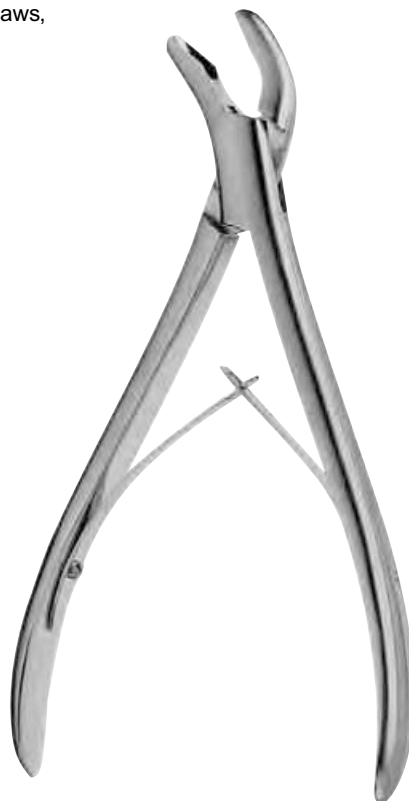

BACON Cranial Rongeur Forceps  
Angular cup-shaped jaws,  
14mm x 6.8mm wide.



◆ KO3054

Overall length  
8-1/4in (21cm).

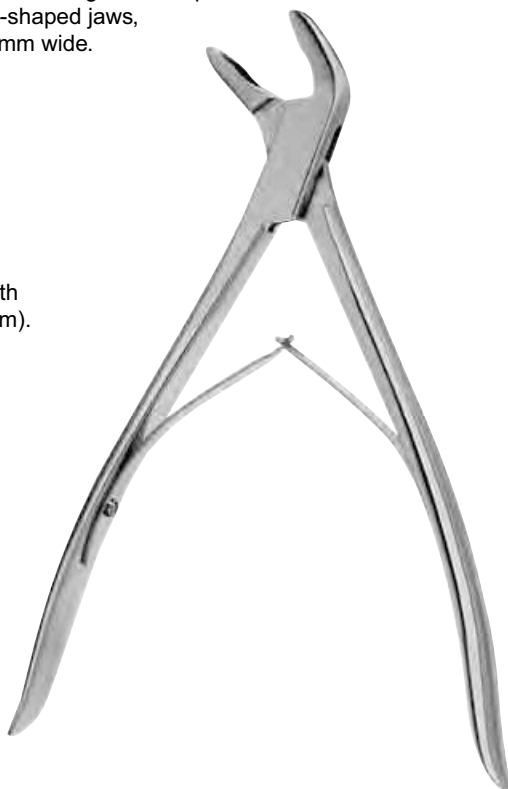

McINDOE Rongeur Forceps  
Double-action, slightly curved.  
Overall length 6in (15.2cm).



◆ KO3055

Jaws 3mm wide.



KO3056  
Jaws 5mm wide.



NEURO/SPINE  
AND ORTHOPEDIC

**KLEINERT-KUTZ Rongeur Forceps**  
Overall length 6in (15.2cm).



**KO3057**

Jaws 3mm wide, small size.



**KO3058**

Jaws 4mm wide, large size.



**ZAUFEL-JANSEN Bone Rongeurs Curved.** Overall length 7in (17.8cm).

**KO 3059**

Jaws 5mm wide.



**STOOKEY Ronguer**  
Overall length 7-1/2in (19cm).

**KO3060**

Angled. 3mm bite.



**SMITH-PETERSEN Rongeurs**

**KO3061**

Straight. 3mm bite.  
Overall length 7-1/2in (19cm).

**KO3062**

Slight curve. 3mm bite.  
Overall length 7-1/2in (19cm).

**KO3063**

Full curve. 3mm bite.  
Overall length 7-1/2in (19cm).

**KO3064**

Straight. 3mm bite.  
Overall length 9-1/2in (24.1cm).

**KO3065**

Slight curve. 3mm bite.  
Overall length 9-1/2in (24.1cm).

**KO3066**

Full curve. 3mm bite.  
Overall length 9-1/2in (24.1cm).

**KO3067**

Straight. 7mm bite.  
Overall length 9in (23cm).

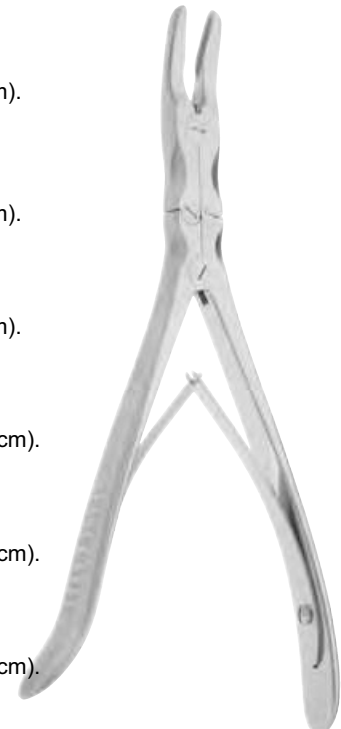



**FULTON Laminectomy Rongeurs**  
Double-action. Bite 5mm wide.

KO3068  
Straight.  
Overall length 7-1/2in (19cm).

**KO3069**  
Curved.  
Overall length 7-1/2in (19cm).

KO3070  
Straight.  
Overall length 9-1/2in (24cm).

KO3071  
Curved.  
Overall length 9-1/2in (24cm).



**KLEINERT-KUTZ Rongeur**  
Curved. 2mm x 13mm bite.



**KO3072**  
Overall length  
6in (15.2cm).



**RUSKIN Mini Rongeurs**  
Bite 15mm x 3mm wide.  
Overall length  
6in (15.2cm).

KO3073  
Straight.

**KO3074**  
Curved.



**RUSKIN Rongeur Forceps**  
Double-action. Overall length 7-1/2in (19cm).



**KO3075**  
Slightly curved jaws.  
5mm wide.

KO3076  
Straight jaws.  
5mm wide.



KO3077  
Slightly curved jaws.  
6mm wide.





**RUSKIN Rongeur Forceps**  
 Duckbill, curved pattern.  
 Cup 6mm x 16mm.

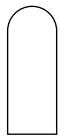

KO3078  
 Overall length  
 7in (17.8cm).



**STILLE-LUER-Type Rongeur Forceps**  
 Double-action. Jaws 10mm wide.  
 Overall length 8-1/2in (21.6cm).

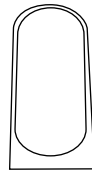

◆ KO3079  
 Straight jaws.

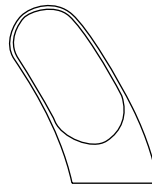

KO3080  
 Curved jaws.



**STILLE-Type Rongeur Forceps**  
 Double-action. Jaws angled to the side.  
 Overall length 9in (22.9cm).

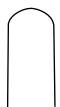

◆ KO3081  
 Jaws 6mm wide.



◆ KO3082  
 Jaws 3mm wide.



**LEKSELL Rongeur Forceps**  
 Double-action. Regular curve.



◆ KO3083  
 Jaws 16mm x 8mm wide. Overall length  
 8-1/2in (21.6cm).



◆ KO3084  
 Jaws 16mm x 5mm wide. Overall length  
 8-1/2in (21.6cm).



◆ KO3085  
 Jaws 16mm x 3mm wide. Overall length  
 9-3/4in (24.8cm).

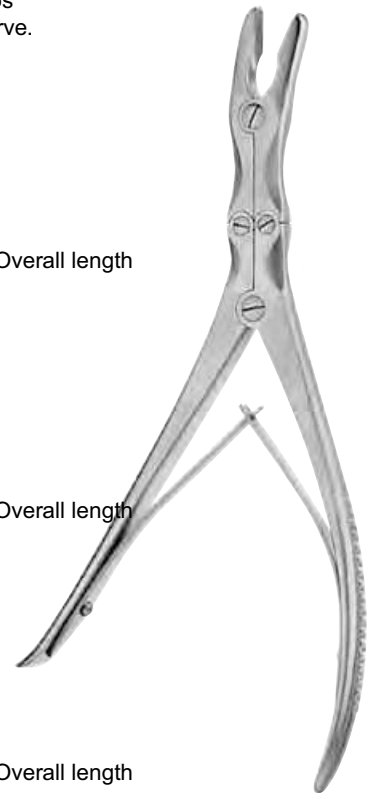

**LEKSELL Rongeur Forceps**  
Double-action. Fully curved.



◆ KO3086

Jaws 13mm x 7mm wide. Overall length 8-1/2in (21.6cm).



KO3087

Jaws 16mm x 5mm wide. Overall length 9-5/8in (24.5cm).



KO3088

Jaws 13mm x 3mm wide. Overall length 9-1/4in (23.5cm).

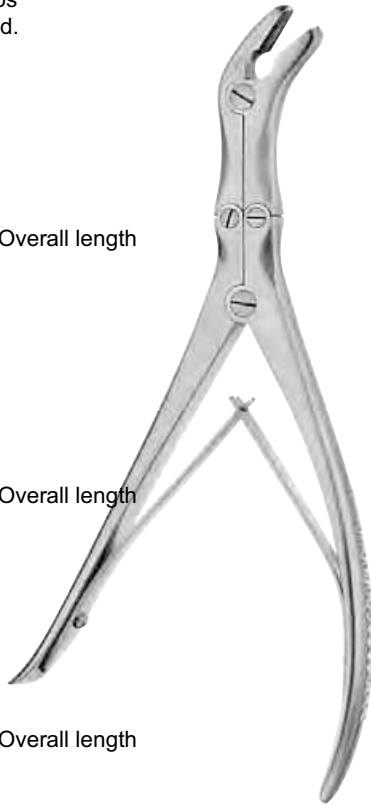

**ECHLIN Rongeur Forceps**  
Double-action. Duckbill pattern, narrow, angular jaws.  
Overall length 9in (22.9cm).



KO3089

Jaws 2mm x 10mm.

KO3090

Jaws 3mm x 10mm.



**DAWSON-YUHL Rongeur Forceps**  
LEMPERT-type. Straight. Jaws 4mm.



KO3091

Overall length 11in (27.9cm).



**DAWSON-YUHL-LEKSELL Rongeur Forceps**  
Angular cup-shaped jaws.  
Overall length 11-1/2in (29.2cm).



KO3092

Jaws 5mm x 13mm.



KO3093

Jaws 2mm x 13mm.



Wire Pulling Forceps  
Capacity 1mm.

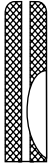

KO3094

Overall length  
6-1/2in (16.5cm).



Needle Nose Pliers  
Overall length 5-1/2in (14cm).

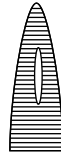

KO3095

Delicate. Tip 1mm wide.

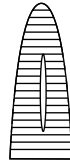

KO3096

Tip 2mm wide.



Long Jaw Needle Nose Pliers  
Tip 2mm wide. Jaw length 5.7cm.

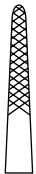

KO3097

Overall length  
6in (15.2cm).



Flat Nose Pliers  
Tip 4mm wide.

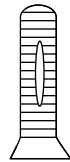

KO3098

Overall length  
5-1/2in (14cm).



Flat Nose Pliers  
Overall length  
7in (17.8cm).

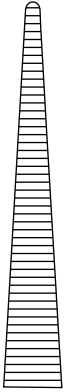

KO3099

Delicate.  
Tip 2mm wide.  
Jaw length 5.1cm.



Flat Nose K-Wire Pliers  
Overall length 6-3/4in (17.1cm).



KO4000  
Tip 5mm wide.

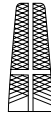

KO4001  
Tip 6mm wide.  
Side grooved.



Utility Pliers  
Slip joint. Tip 10mm wide.

KO4002

Overall length  
7-3/4in (19.7cm).



Parallel Pliers  
Maximum opening 13mm.  
Jaw 10mm wide.

KO4003

Overall length  
7-1/2in (19.1cm).



Needle Nose Locking Pliers  
Tip 5mm wide. Jaw length 5.7cm.

KO4004

Overall length  
9-3/4in (24.8cm).



Heavy Duty Locking Pliers  
Jaw 9mm wide.

KO4005

Overall length  
8in (20.3cm).



VITAL® Pin Pulling Pliers  
Tip 3mm wide. Tungsten Carbide inserts.

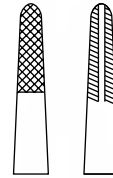

KO4006

Overall length  
5-3/4in (14.6cm).



VITAL® Wire Extraction Pliers  
Double-action. Overall length  
7-1/2in (19.1cm). Tungsten Carbide inserts.

KO4007

Jaws 2mm wide.



KO4008

Jaws 4mm wide.

KO4009

Jaws 6mm wide.

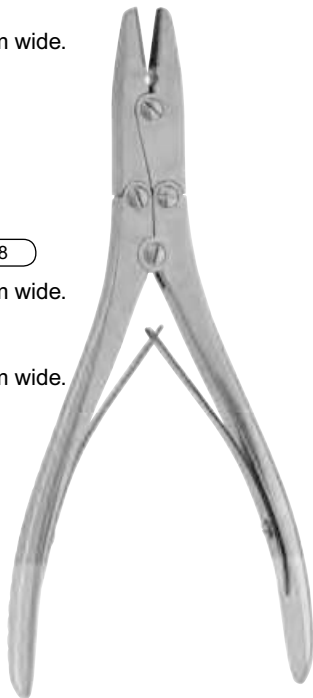

Needle Nose Pliers/Wire Cutter

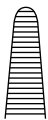

KO4010

Overall length  
6-3/8in (16.2cm).



VITAL® Heavy-Duty Pliers/Wire  
Cutter  
Overall length  
8-1/2in (21.6cm).

KO4011



VITAL® Wire Cutter  
Capacity 1.6mm.

◆ KO4012

Overall length  
8in (20.3cm).



VITAL® Wire Cutters  
Double-action. Side cutting. Angled.

◆ KO4013

Capacity 1.6mm.  
Overall length  
6-1/2in (16.5cm).

◆ KO4014

Capacity 2.4mm.  
Overall length  
9in (22.9cm).



VITAL® Wire Cutter  
Side cutting.  
Capacity 2.4mm.

◆ KO4015

Overall length  
9in (22.9cm).



VITAL® Wire Cutter  
Double-action. Front and side cutting.  
Capacity 1.6mm.

◆ KO4016

Overall length  
6-3/4in (17.1cm).



VITAL® Flush Wire/Cable Cutter  
Double action. Front and side cutting.  
Capacity 1.6mm.

◆ KO4017

Overall length  
6-3/4in (17.1cm).



VITAL® Wire Cutter  
End cutting. Capacity 1.6mm.  
Tungsten Carbide inserts.

◆ KO4018

Overall length  
5-3/4in (14.6cm).





VITAL® Wire Cutter  
Capacity 2.4mm.

KO4019

End cutting.  
Overall length  
8-1/2in (21.6cm).



VITAL® Cable Cutter  
Capacity 2mm.

KO4020

Overall length  
7in (17.8cm).



VITAL® Advanced Wire Cutters  
Tungsten Carbide blades and rubber jaws.

KO4021

Overall length  
7in (18cm).  
Left handed.  
For drill wires  
up to 2.2mm.

KO4022

Overall length  
7in (18cm).  
Right-handed.  
For drill wires  
up to 2.2mm.

KO4023

Overall length  
9in (23cm).  
For drill wires  
up to 3mm.

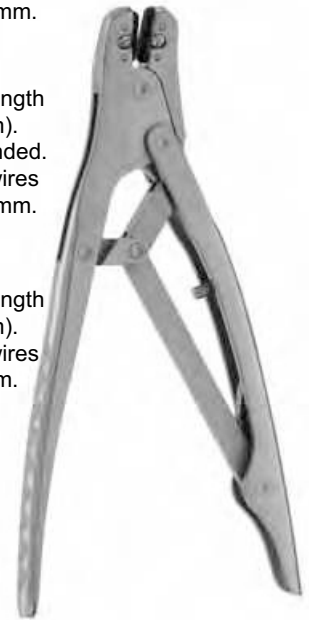

VITAL® Advanced Front and Side  
Cutters  
Tungsten Carbide blades and rubber jaws. For  
drill wires up to 1.6mm.

KO4024

Overall length  
7in (18cm).



VITAL® Advanced Cable Cutters  
Tungsten Carbide blades. For cables 1-2mm.

KO4025

Overall length  
7in (18cm).



VITAL® Advanced Extraction  
Forceps  
Tungsten Carbide jaws.

KO4026

Overall length  
7in (18cm).  
Jaw size 3mm.

KO4027

Jaw size 6mm.

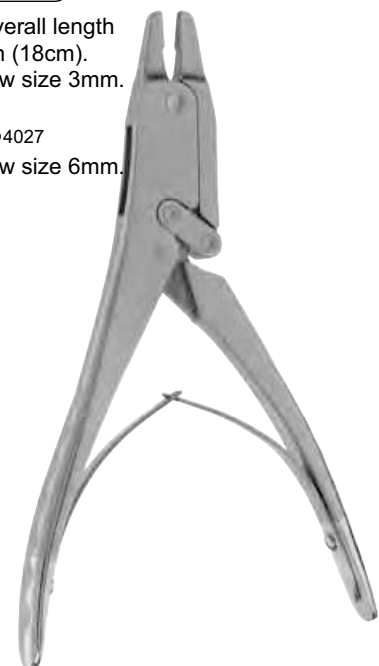



Vital<sup>®</sup> Advanced Wire Cutters Replacement Parts

KO4028

One pair tungsten carbide replacement blades.  
Two pairs of screws. Allen key. For OS3031 and OS3032.

KO4029

One pair rubber replacement jaws. For OS3031 and OS3032.

KO4030

One pair tungsten carbide replacement blades.  
Two pairs of screws. Allen key. For OS3033.

KO4031

One pair tungsten carbide replacement blades.  
Two pairs of screws. Allen key. For OS3034.

KO4032

One pair tungsten carbide replacement blades.  
One pairs of screws. Allen key. For OS3036.



MARTIN Diamond Wire Cutter

KO4033

1.25mm capacity.  
Overall length  
6-1/2in (16.5cm).



Cannulated Pin Cutter  
End cutting. Capacity 1.6mm.

KO4034

Overall length  
7-1/4in (18.4cm).



Pin Cutters  
End cutting.

KO4035

Capacity 3mm.  
Overall length  
10-1/4in (26cm).

KO4036

Capacity 4.7mm.  
Overall length  
14-3/4in (37.5cm).

KO4037

Capacity 6.3mm.  
Overall length  
22in (55.9cm).



Pin Cutter

Side cutting. Capacity 6.3mm.  
Overall length 22-3/8in (56.8cm).

◆ KO4038

KO4039

Removable handles.



BUNNELL Dissecting Probe  
Angled.

KO4039

Overall length  
5-1/2in (14cm).



BUNNELL Tendon Passers and  
Forwarding Probes  
Polished finish.

KO4040

Overall length  
7-3/8in (18.7cm).

KO4041

Overall length  
8-7/8in (22.5cm).



Tendon Passers  
Overall length 6in (15.2cm).



◆ KO4042

Straight pointed tip.

KO4043  
Curved pointed tip.



Tendon Braiding Forceps  
Small size. Delicate, sharp point.  
Single-pin tooth. Overall length 4-3/4in (12cm).

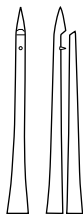

KO4044

Straight.

KO4045  
Curved.

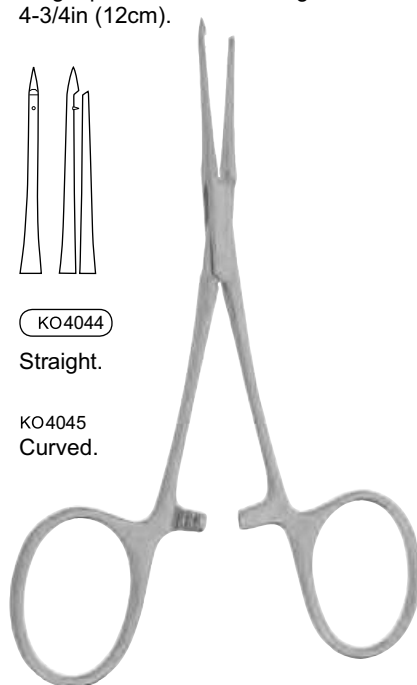

KLEINERT-KUTZ Tendon Retriever  
Small size.



KO4046

Overall length 8-1/4in (21cm).

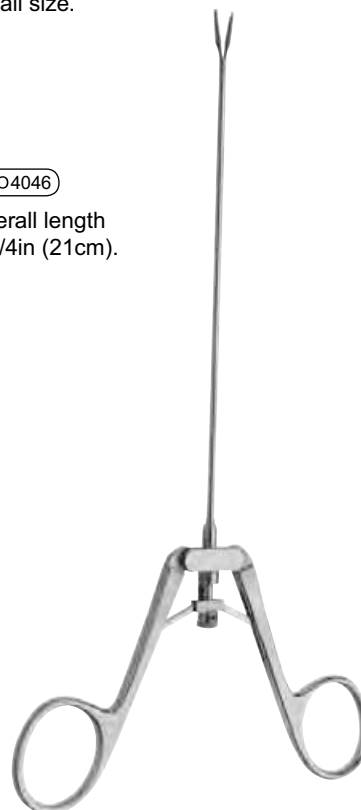

CAROLL Tendon Pulling Forceps  
Curved. Serrated.



◆ KO4047

Overall length 5-1/2in (14cm).



BRAND Tendon Forceps  
Angled.



KO4048

Overall length 7-1/2in (19cm).

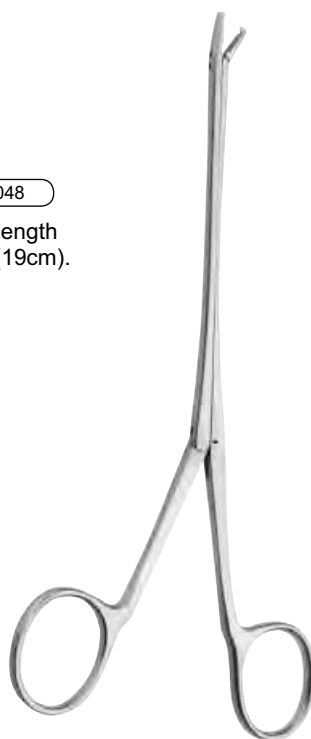

BRAND Tendon Tunneling or Passing Forceps  
Curved. Alligator-type.

KO4049  
Overall length 6in (15.2cm).



KO4050

Overall length 9-1/4in (23.5cm).



NEURO/SPINE  
AND ORTHOPEDIC

**Tendon Forceps**  
Straight, slender, with  
2 x 3 delicate teeth.  
Double-action.



KO4051

Overall length  
8in (20.3cm).

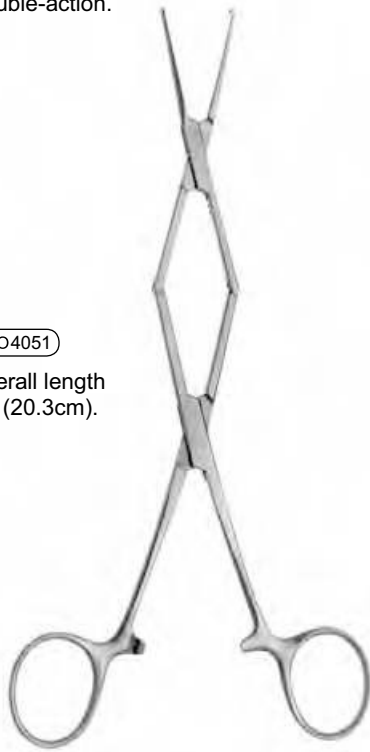

**BUNNELL Tendon Strippers**  
Overall length  
6in (15.2cm).

KO4052

Size 1, tip 3mm wide.

KO4053

Size 2, tip 4mm wide.

KO4054

Size 3, tip 5mm wide.

KO4055

Size 4, tip 6mm wide.

KO4056

Size 5, tip 7mm wide.



**Tendon Strippers**  
Flexible shaft.  
Overall length  
8-3/4in (22cm).

KO4057

4mm diameter.

KO4058

4.5mm diameter.

KO4059

5.5mm diameter.

KO4060

6mm diameter.

KO4061

7mm diameter.



**Tendon Strippers**  
Autoclavable handle.

KO4062

3mm inner diameter.  
Overall length  
11in (28.5cm).

KO4066

3mm inner diameter.  
Overall length  
24in (60cm).

KO4070

5mm inner diameter.  
Overall length  
14in (35cm).

KO4063

6mm inner diameter.  
Overall length  
14in (35cm).

KO4067

4mm inner diameter.  
Overall length  
14in (35cm).

KO4071

5mm inner diameter.  
Overall length  
20in (50cm).

KO4064

6mm inner diameter.  
Overall length  
24in (60cm).

KO4068

4mm inner diameter.  
Overall length  
24in (60cm).

KO4072

5mm inner diameter.  
Overall length  
24in (60cm).

KO4065

3mm inner diameter.  
Overall length  
14in (35cm).

KO4069

5mm inner diameter.  
Overall length  
11in (28.5cm).



**Meniscus Clamp**  
Curved shank.  
1 x 2 teeth at tips of jaws.

KO4073

Overall length  
7-1/8in (18.1cm).



**MENISCUS Clamps**  
(Slocum-Style)  
Serrated. Overall length  
5-3/8in (13.7cm).

KO440  
Straight.

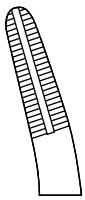

KO4074  
Angled.

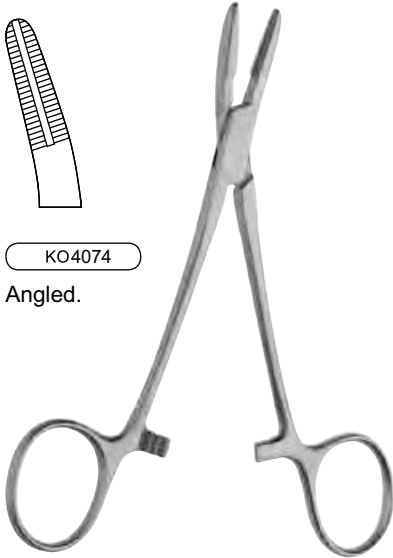

**SMILLIE**  
Meniscus  
Knives  
Overall length  
6-3/4in (17.1cm).

KO4075  
Straight, chisel-type  
blade.

KO4076  
Curved blade No. 1.

KO4077  
Curved blade No. 2.

KO4078  
Straight.

KO4079  
Curved left.

KO4080  
Curved right.

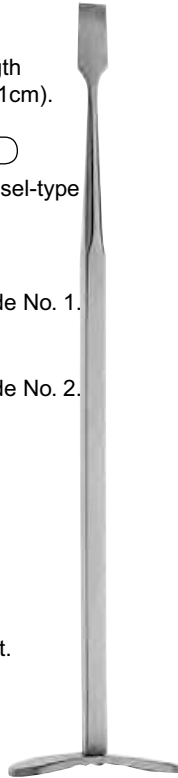

**DOWNING** Cartilage  
Knife  
Aluminum handle.

KO4081  
Overall length  
9-3/8in (23.8cm).



**MARTIN** Cartilage  
Scissors  
Curved, serrated blades,  
5.3cm from mid-screw.

KO4082  
Overall length  
8in (20.3cm).

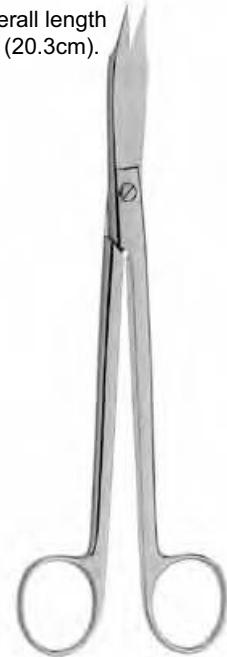

**CRAIG Vertebral Body Biopsy Instrument Sets**  
The cannula hub is tapered to fit a Luer syringe.  
Matte and Mirror finish.



KO4083  
Set includes:

Part No.	Description	Set Qty.
OS5000-001	CRAIG worm hook. Overall length 8-1/2in (21.6cm).	1
OS5000-002	CRAIG toothed cutters. Overall length 7-3/8in (18.7cm).	2
OS5000-003	CRAIG calibrated blunt trocars. Overall length 10in (25.4cm)	2
OS5000-004	CRAIG stylet pusher. Overall length 8-3/8in (21.3cm).	1
OS5000-005	CRAIG calibrated cannula. Overall length 5-3/8in (13.7cm).	1
OS5000-006	CRAIG needle and guard. 20GA.	1
OS5000-007	CRAIG needle and guard. 22GA.	1
OS5000-008	CRAIG socket wrench.	1
OS5000-009	CRAIG storage rack.	1

Individual components can be purchased separately

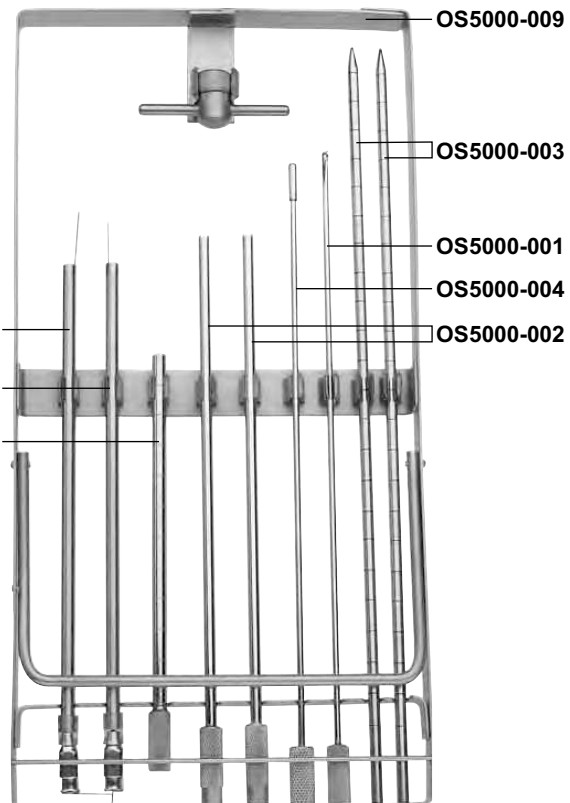

**MICHELE Trephines**  
 Working length  
 6-1/4in (15.9cm).  
 Matte and Mirror finish.

KO4083

Small.  
 Diameter 4.8mm.

KO4084  
 Medium.  
 Diameter 5.5mm.

KO4085  
 Large.  
 Diameter 7.9mm.

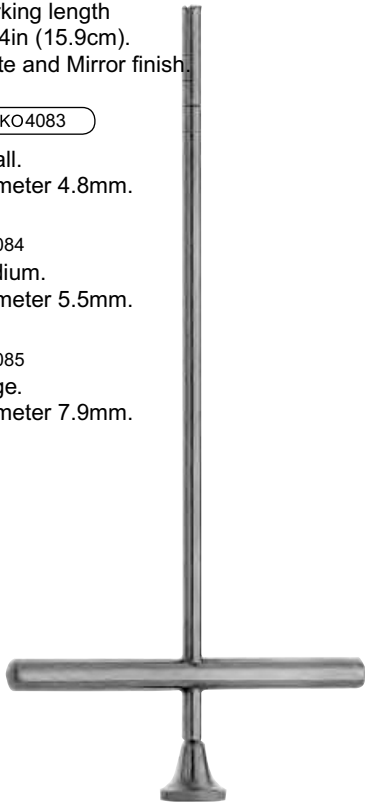

**POLLEY-BICKEL Biopsy Trephine Set**  
 Mirror and Satin finish.

KO4086



**Ingrown Nail Forceps**  
 Anvil-type.

KO4087

Overall length  
 5in (12.7cm).

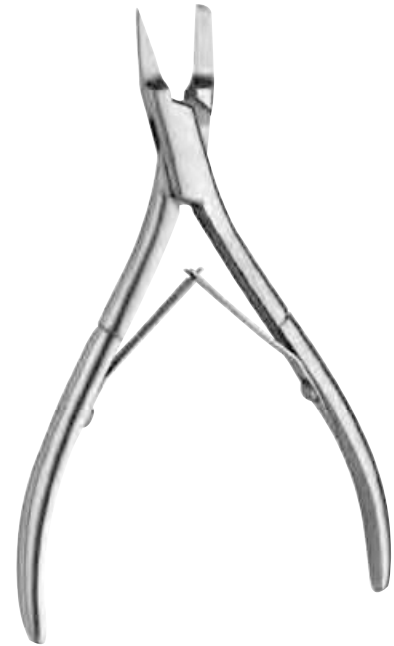

**Platypus Nail Removing Forceps**  
 Jaw 7mm wide.



KO4088

Overall length  
 5-1/2in (14cm).



**HERCULES Plaster Shears**

KO4089

Overall length  
 7-1/2in (19.1cm).



**Utility Plaster Shears**  
 Serrated.

KO4090

Overall length  
 8in (20.3cm).





Heavy Duty Plaster Shears

KO4091

Esmarch-type.  
Probe point,  
angled on side.  
Overall length  
9in (22.9cm).



BRUNS Shears  
Serrated.

KO4092

Overall length  
9-1/2in (24.1cm).



WALTON Cast Spreader  
Serrated.

KO4093

Overall length  
9in (22.9cm).



HENNIG Cast Spreader

KO4094

Overall length  
10-7/8in (27.6cm).



Small Cast Remover

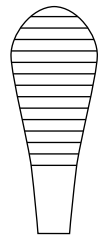

KO4095

Overall length  
7in (17.8cm).

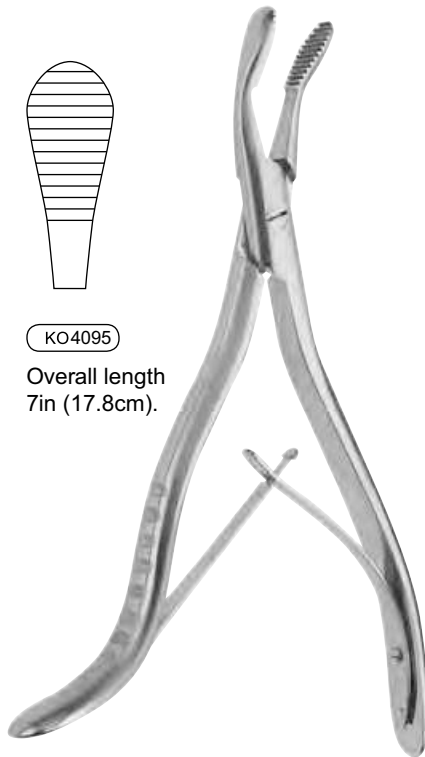

WOLFF-BOEHLER Cast Remover

KO4096

Overall length  
8in (20.3cm).





---

### TOWNLEY Femur Caliper

◆ KO4097

Working length  
4in (10cm).



---

### STARRETT Pin Vise

For driving fine twist drills.  
Has swivel finger rest on proximal end for easier drilling.

KO4098

Overall length  
3in (7.6cm).



---

### Customer Support

Our highly trained, centralized V. Mueller customer support team is available to take your calls from 7:00 a.m. to 6:00 p.m. (CST), M-F. This group is dedicated to providing a full range of support services, including:

- Order placement
- Order inquiries
- Delivery information
- Product information
- Pricing inquiries

---

### BUNNELL Hand Drill

Cannulated to accommodate wires and small diameter drills.  
Lightweight, with gears completely enclosed. JACOBS chuck key fits in handle.

◆ KO4099

5/32in (3.95mm).



---

### Universal Rod Bender

KO5000

Overall length  
11-1/2in (29.2cm).



### Quick Coupling Drill Bits

KO5001  
Diameter 1.1mm.  
Overall length 2-3/8in (6cm).

KO5002  
Diameter 1.5mm.  
Overall length 3-3/8in (8.5cm).

KO5003  
Diameter 2.0mm.  
Overall length 3-7/8in (10cm).

KO5004  
Diameter 2.5mm.  
Overall length 4-3/8in (11cm).

KO5005  
Diameter 2.7mm.  
Overall length 3-7/8in (10cm).

KO5006  
Diameter 3.2mm.  
Extra large thread.  
Overall length 7-5/8in (19.5cm).

**KO5007**  
Diameter 3.2mm.  
Overall length 5-3/4in (14.5cm).

KO5008  
Diameter 3.5mm.  
Overall length 3-7/8in (10cm).

KO5009  
Diameter 3.5mm.  
Overall length 6-3/4in (17cm).

KO5010  
Diameter 4.5mm.  
Overall length 5-3/4in (14.5cm).

KO5011  
Diameter 6.0mm.  
Extra large thread.  
Overall length 7-5/8in (19.5cm).



To learn how the IMPRESS system can help improve process performance, reduce immediate-use steam sterilization, decrease case delays, and improve patient care by monitoring instrument flow within your facility, contact your V. Mueller sales representative.

### JACOBS Drill Bits

KO5012  
Diameter 1.1mm.  
Overall length 1-3/4in (4.5cm).

KO5013  
Diameter 2.7mm.  
Overall length 3-3/8in (8.5cm).

KO5014  
Diameter 1.5mm.  
Overall length 2-3/4in (7cm).

KO5015  
Diameter 2mm.  
Overall length 3-7/8in (10cm).

KO5016  
Diameter 2.5mm.  
Overall length 3-3/4in (9.5cm).

KO5017  
Diameter 3.2mm.  
Overall length 5-1/8in (13cm).

KO5011  
Diameter 3.2mm.  
Overall length 7-1/8in (18cm).

**KO5018**  
Diameter 3.5mm.  
Overall length 3-3/4in (9.5cm).

KO5019  
Diameter 3.5mm.  
Extra large thread.  
Overall length 7-1/8in (18cm).

KO5020  
Diameter 4.5mm.  
Extra large thread.  
Overall length 7-1/8in (18cm).

KO5021  
Diameter 6mm.  
Extra large thread.  
Overall length 7-5/8in (19.5cm).



Fluted Drill Bits  
Overall length 9in (23cm).

KO5022  
Diameter 2.5mm.

KO5023  
Diameter 3.2mm.

KO5024  
Diameter 4.5mm.

NEUROSPINE  
AND ORTHOPEDIC

---

Screwdrivers

KO5025  
Single slot.  
Overall length 6-3/4in (17cm).

KO5026  
Single slot.  
Overall length 10in (25.4cm).

**KO5027**  
Phillips.  
Overall length 10in (25.4cm).



---

K-Wire Ruler and Pin Gauge

**KO5028**  
Overall length 6in (15.2cm).



---

Flexible Ruler  
Overall length 12in (30.5cm).

**KO5029**  
13mm wide.



---

Metric Ruler  
Deeply etched with accurate scales.

**KO5030**  
Length 6in (15cm).



---

T-Handle Corkscrew

**KO5031**  
Overall length  
7-1/2in (19cm).





KO5032

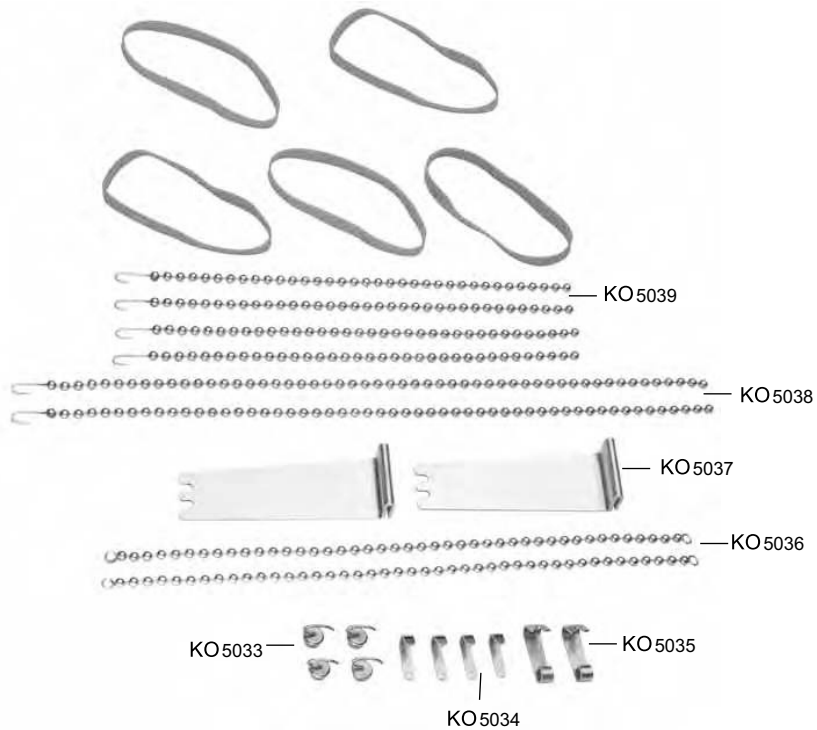

TUPPER-Type Hand Table  
Set includes 1 each of the following:

(KO5040)

Part No.	Description
OS6200	TUPPER-type hand table. Supports enough weight to withstand all passive torsion force of the supinated or pronated forearm. Numerous notches around the table's perimeter anchor the ball chains. 7 pairs of the slots for Sliding Hooks OS6207, 1 for each digit, arm and wrist. Faces 2 ways, for both left and right hand procedures.
OS6201	Elevated chain holders. Placed anywhere around Hand Table OS6200. Act as elevated anchor points for chains wherever clearance or an elevated pull above the flexed finger is necessary. 2 per package.
OS6202	Chain holder hooks. Allows 1 chain to serve as an anchor point for another chain. Aids in proximal retraction along the axis of the limb. 2 per package.
OS6205	Ball chains without hooks. Secures arm and wrist. Chains are attached to the table edge at each end. 2 per package.
OS6206	Tendon hooks. Facilitates the traumatic retraction of tendons and wound edges when attached to the hooks of OS6203 or OS6204. 4 per package.
OS6207	Sliding hooks. For rubber bands. Provide anchor points for Rubber Bands OS6208 when placed at any point along the slots.
OS6208	Rubber bands. Pulls digits downward at any point along thier length. 5 per package.
OS6209	Carrying case. For table OS6200 and accessories. Stainless steel.

**Ball Chains With Hooks**

For wound edge and fingertip retraction. Chains have an interval of 6cm and can be placed in the table edge, elevated chain holders or chain holder hooks.

- OS6204 Length 8-1/4in (21cm). 4 per package.
- OS6203 Length 12-1/2in (32cm). 2 per package.

Optional accessory. Not included in set OS6220.

- OS6210 Oval box. For accessories OS6201 through OS6208. 130mm x 8mm wide.

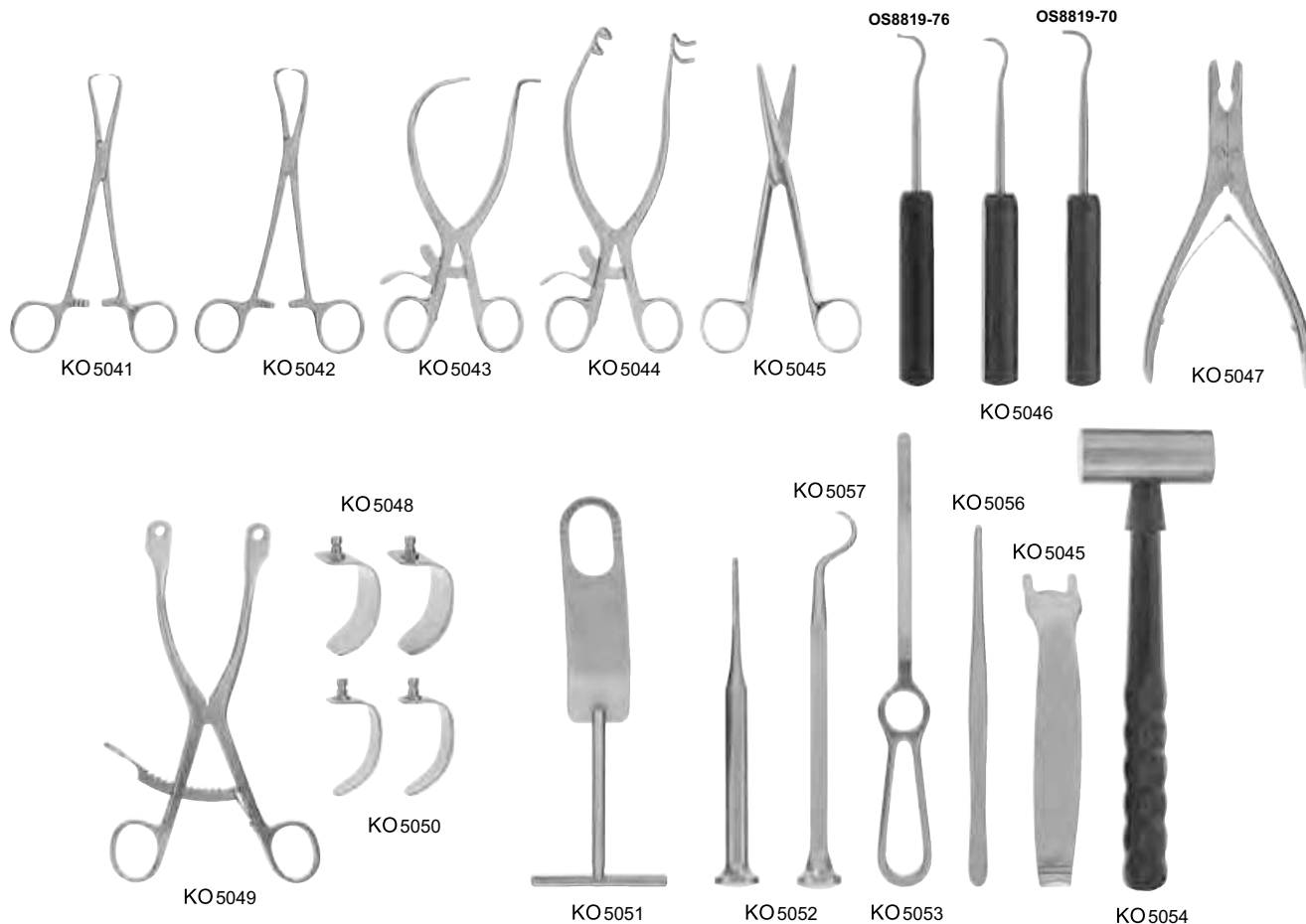

**BANKART-KOLBEL-Type Standard Shoulder Repair Set**  
 Components can be ordered separately. Set includes 1 each of the following:

**KO5058**

Part No.	Description	Part No.	Description
KO5058	Penetrating gouge. 3mm. Overall length 8-1/4in (21cm).	KO5067	KOLBEL-type glenoid lever. 15mm wide. Overall length 12in (30.5cm).
KO5059	RICHARDSON-type retractor. Blade 55mm x 22mm. Overall length 9-1/2in (24cm).	KO5068	KOLBEL-type glenoid lever. 20mm wide. Overall length 12in (30.5cm).
KO5060	Capsule spreader. Angled 90°. Overall length 6-1/8in (15.5cm).	KO5069	Skid lever. Double-ended. Overall length 11in (27.9cm).
KO5061	KOLBEL-type tissue forceps. Serrated. 1 x 2 teeth. Overall length 8-1/4in (21cm).	KO5070	KOLBEL-type soft tissue retractor. Angled. 2 x 2 prongs. Overall length 7in (17.8cm).
KO5062	Percussion awl. With metal handle. Overall length 8-5/8in (22.1cm).	KO5071	KOLBEL-type retractor frame. Ring-handled. Overall length 8in (20.3cm).
KO5063	Penetrating awl. With phenolic handle. Overall length 7-1/4in (18.4cm).	KO5072	KOLBEL-type retractor blades. Pair. Blades 36mm x 36mm wide.
KO5064	Crochet hook suture passer. Overall length 7-1/4in (18.4cm).	KO5073	KOLBEL-type retractor blades. Pair. Blades 53mm x 36mm wide.
KO5065	Hollow lumen suture passer. Overall length 7-1/4in (18.4cm).	KO5074	KOLBEL-type retractor blades. Pair. 68mm x 36mm wide.
KO5066	Glenoid perforation forceps. Light angle. Overall length 6-3/4in (17.1cm).	KO5075	KOLBEL-type retractor blades. Pair. 85mm x 36mm wide.
KO5067	Glenoid perforation forceps. Strong angle. Overall length 6-3/4in (17.1cm).	KO5076	Mallet. Head 25mm. Overall length 9-1/2in (24.1cm).
KO5068	Humeral head retractor. Overall length 7in (17.8cm).	KO5077	Bone nibbling rongeur. 5mm. Overall length 7-1/2in (19.1cm).
KO5069		KO5078	Capsule and tendon scissors. Overall length 6-3/4in (17.1cm).

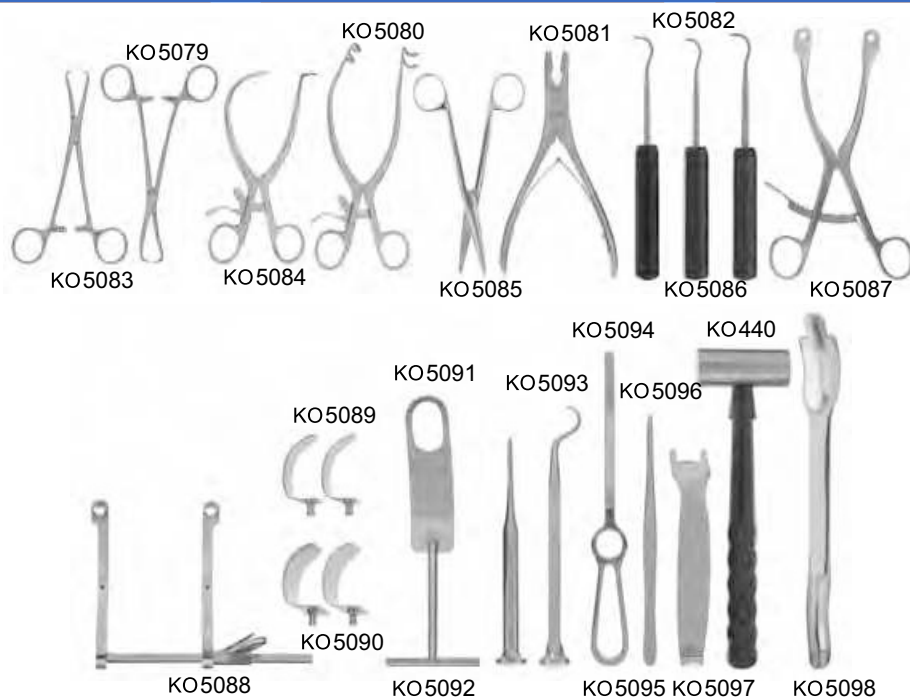

**BANKART/KOLBEL-Type Expanded Repair Set**

Components can be purchased separately. Set includes 1 each of the following:

**(KO5099)**

Part No.	Description	Part No.	Description
KO5091	Penetrating gouge. 3mm. Overall length 8-1/4in (21cm).	KO6009	KOLBEL-type retractor blades. Pair. Blades 68mm x 36mm wide.
KO5092	RICHARDSON-type retractor. Blade 55mm x 22mm. Overall length 9-1/2in (24cm).	KO6010	KOLBEL-type retractor blades. Pair. Blades 85mm x 36mm wide.
KO5093	Capsule spreader. Angled 90°. Overall length 6-1/8in (15.5cm).	KO6011	KOLBEL-type retractor blades. Pair. Blades 36mm x 20mm wide.
KO5094	KOLBEL-type tissue forceps. Serrated. 1 x 2 teeth. Overall length 8-1/4in (21cm).	KO6012	KOLBEL-type retractor blades. Pair. Blades 53mm x 20mm wide.
KO5095	Percussion awl. With metal handle. Overall length 8-5/8in (22.1cm).	KO6013	KOLBEL-type retractor blades. Pair. Blades 68mm x 20mm wide.
KO5096	Penetrating awl. With phenolic handle. Overall length 7-1/4in (18.4cm).	KO6014	KOLBEL-type retractor blades. Pair. Blades 85mm x 20mm wide.
KO5097	Crochet hook suture passer. Overall length 7-1/4in (18.4cm).	KO6015	KOLBEL-type retractor frame. Crank-style.
KO5098	Hollow lumen suture passer. Overall length 7-1/4in (18.4cm).	KO6016	DARRACH-type acromonial lever. 9mm x 260mm wide.
KO5099	Glenoid perforation forceps. Light angle. Overall length 6-3/4in (17.1cm).	KO6017	DARRACH-type acromonial lever. 12mm x 260mm wide.
KO6000	Glenoid perforation forceps. Strong angle. Overall length 6-3/4in (17.1cm).	KO6018	DARRACH-type acromonial lever. 18mm x 260mm wide.
KO6001	Humeral head retractor. Overall length 7in (17.8cm).	KO6019	DARRACH-type acromonial lever. 25mm x 260mm wide.
KO6002	KOLBEL-type glenoid lever. 15mm wide. Overall length 12in (30.5cm).	KO6020	KUJAT-FUKUDA-type humeral head retractor. Overall length 9in (22.9cm).
KO6003	KOLBEL-type glenoid lever. 20mm wide. Overall length 12in (30.5cm).	KO6021	Mallet. Head 25mm. Overall length 9-1/2in (24.1cm).
KO6004	Skid lever. Double-ended. Overall length 11in (27.9cm).	KO6022	Bone nibbling rongeur. 5mm. Overall length 7-1/2in (19.1cm).
KO6005	KOLBEL-type soft tissue retractor. Angled. 2 x 2 prongs. Overall length 7in (17.8cm).	KO6023	Capsule and tendon scissors. Overall length 6-3/4in (17.1cm).
KO6006	KOLBEL-type retractor frame. Ring handled. Overall length 8in (20.3cm).	Optional component for OS1400 and OS1450 (not included in set):	
KO6007	KOLBEL-type retractor blades. Pair. Blades 36mm x 36mm wide.	KO6024	Chisel system. With handle and three blades.
KO6008	KOLBEL-type retractor blades. Pair. Blades 53mm x 36mm wide.		



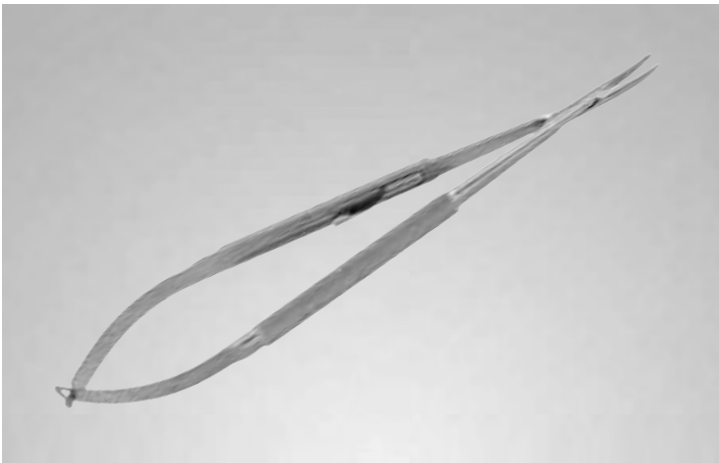
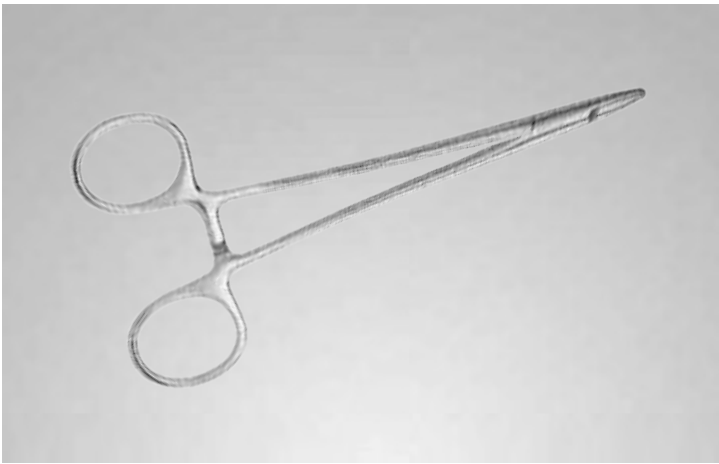
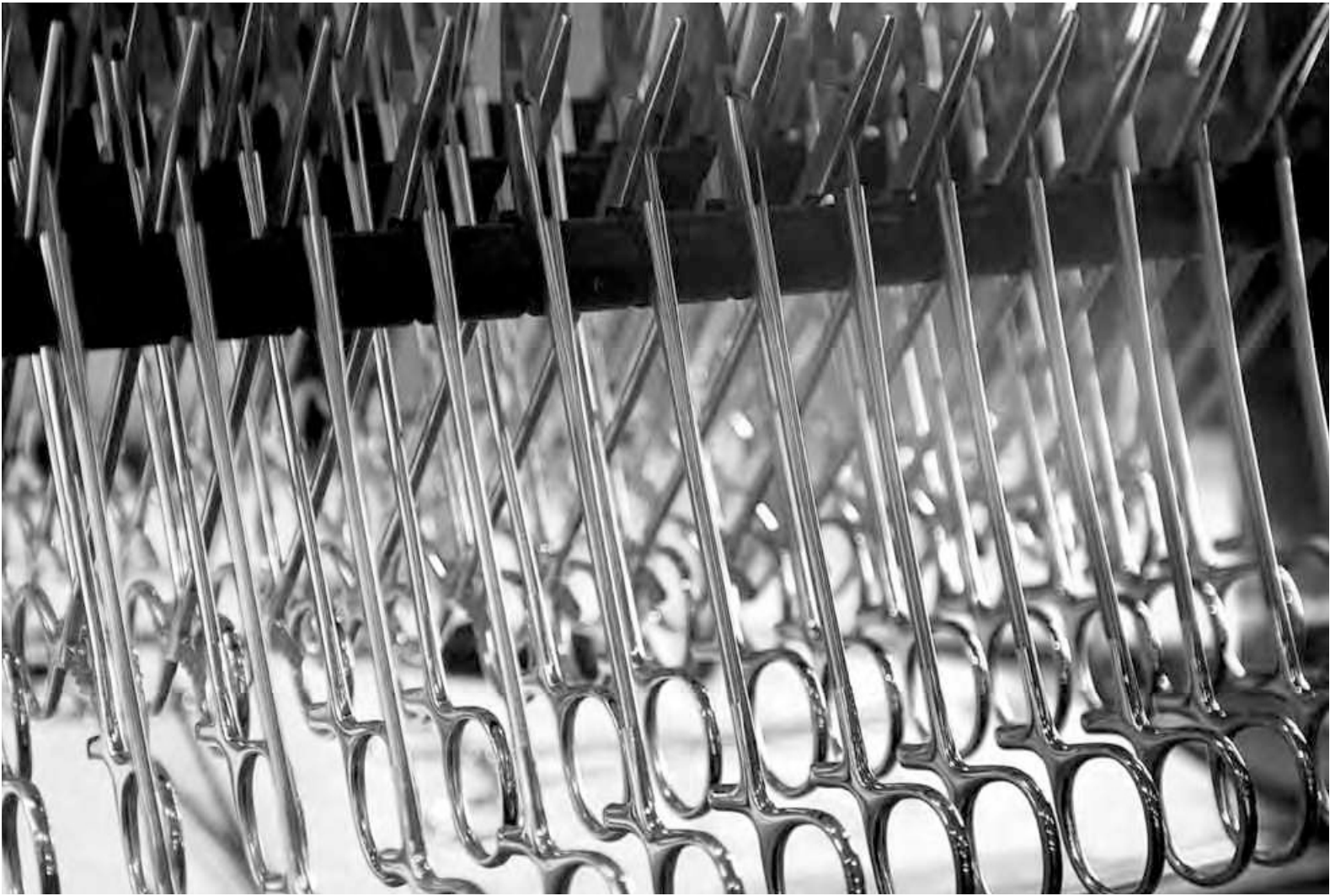



# Neuro/Spine and Orthopedic Instruments

Curettes, Kerrison Ronguers, Shadow-Line  
and McCulloch Retraction Sets

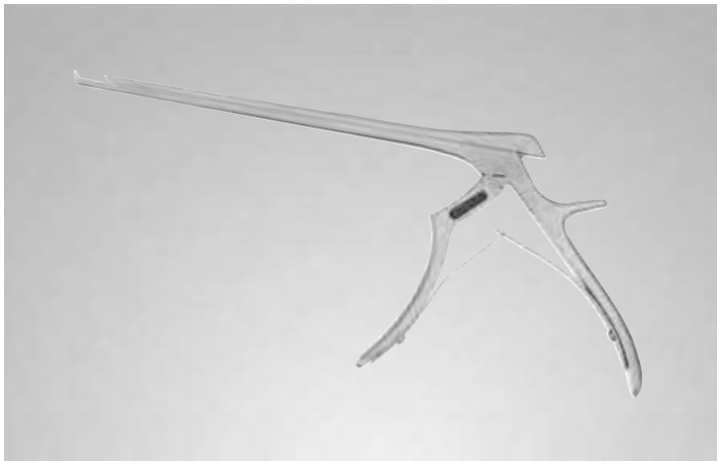

**MEYERDING Retractors**

Overall length  
7-7/8in (20cm).

(KO6025)

Blades  
2-3/8in x 1in  
(6cm x 2.5cm).

KO6026  
Blades  
2-1/8in x 1in  
(5.4cm x 2.5cm).

KO6027  
Blades  
1-3/4in x 1in  
(4.4cm x 2.5cm).



**MARKHAM-MEYERDING Retractors**

Self-retaining. Blade 2in x 1in (5.1cm x 2.5cm) wide.  
Overall length 7-1/2in (19cm).

KO6028  
Blade on right.  
Sharp tenaculum on left.

(KO6029)  
Blade on left.  
Sharp tenaculum on right.

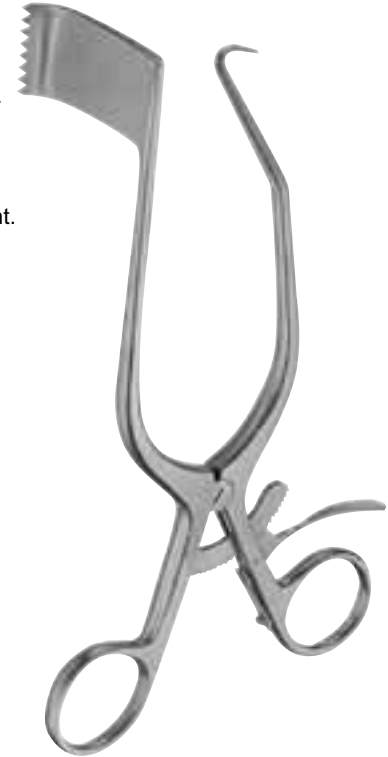

**WILLIAMS-Style Dissectomy Retractors**  
Narrow. Overall length 7in (17.8cm).

Right Hook	Left Hook	Blade Size (length x width)
(NL5390-002)	NL5390-006	50mm x 20mm
NL5390-003	NL5390-007	60mm x 20mm
NL5390-004	NL5390-008	70mm x 20mm
NL5391-002	NL5391-006	50mm x 10mm
NL5391-003	NL5391-007	60mm x 10mm
NL5391-004	NL5391-008	70mm x 10mm



Micro Spine Retractors  
Overall length 7in (18cm).

KO6030  
Blade 50mm x 10mm wide. Left.

KO6036  
Blade 50mm x 20mm wide. Left.

**(KO6031)**  
Blade 50mm x 10mm wide. Right.

KO6037  
Blade 50mm x 20mm wide. Right.

KO6032  
Blade 60mm x 10mm wide. Left.

KO6038  
Blade 60mm x 20mm wide. Left.

KO6033  
Blade 60mm x 10mm wide. Right.

KO6039  
Blade 60mm x 20mm wide. Right.

KO6034  
Blade 70mm x 10mm wide. Left.

KO6040  
Blade 70mm x 20mm wide. Left.

KO6035  
Blade 70mm x 10mm wide. Right.

KO6041  
Blade 70mm x 20mm wide. Right.



BECKMAN-ADSON Retractors  
Overall length  
12in (30cm).  
4 x 4 prongs.

◆ **(KO6042)**  
Prongs 25mm x 25mm. Sharp.

KO6043  
Prongs 25mm x 44mm. Blunt.

KO6044  
Prongs 25mm x 44mm. Sharp.

KO6045  
Prongs 25mm x 25mm. Blunt.



BECKMAN-ADSON Spine Retractor  
Overall length  
10in (25.5cm).  
3 x 4 prongs.

**(KO6046)**  
Sharp prongs.



CLOWARD Cervical Retractors Set  
Blunt. Includes 7 pairs of toothed blades from 25mm to 55mm.  
Overall length 6-3/4in (17.2cm). Set includes the following:

**KO6047**

Part No.	Description	Quantity
KO6048	Hinged retractor frame 6-3/4in (17.2cm)	1 Each
KO6049	25mm blades	2 Each
KO6050	30mm blades	2 Each
KO6051	35mm blades	2 Each
KO6052	40mm blades	2 Each
KO6053	45mm blades	2 Each
KO6054	50mm blades	2 Each
KO6055	55mm blades	2 Each



CLOWARD Cervical Retractor Set  
Sharp. Includes 7 pairs of toothed blades from 25mm to 55mm.  
Overall length 10in (25.4cm). Set includes the following:

Part No.	Description	Quantity
KO6056	Hinged Retractor Frame 10in (25.4cm)	1 Each
KO6057	25mm blades	2 Each
KO6058	30mm blades	2 Each
KO6059	35mm blades	2 Each
KO6060	40mm blades	2 Each
KO6061	45mm blades	2 Each
KO6062	50mm blades	2 Each
KO6063	55mm blades	2 Each



CLOWARD Retractor  
Frame  
Hinged.

**KO6064**

Overall length  
10in (25.4cm).

KO6065  
Overall length  
6-3/4in (17.2cm).

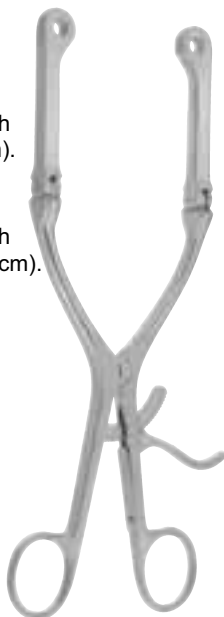

CLOWARD Blades  
Sold separately.

Blunt	Toothed Blades	
	Sharp Prongs	Blade Width
NL5244-25	NL5243-25	25mm
NL5244-30	NL5243-30	30mm
NL5244-35	NL5243-35	35mm
NL5244-40	NL5243-40	40mm
NL5244-45	NL5243-45	45mm
NL5244-50	NL5243-50	50mm
NL5244-55	NL5243-55	55mm
NL5244-60	<b>NL5243-60</b>	60mm



**OBERHILL Retractor**

Self-retaining, with ratchet catch.  
Adjustable swivel arms have  
4-pronged blades  
25mm x 25mm wide.

**KO6066**

Overall length  
12-1/4in (31.1cm).



**BECKMAN-EATON Retractor**

Self-retaining, with ratchet catch.  
Adjustable swivel arms have  
7-pronged blades  
51mm x 45mm wide.

**KO6067**

Overall length  
12-5/8in (32cm).



**SCOVILLE Retractors**

With 1 blunt hook blade, 2in (5.1cm) deep (NL5240-001) and  
1 HIBBS-type blade, 4in deep x 2in wide (10.2cm x 5.1cm) (NL5240-026).  
Arm 6in x 8in (15.2cm x 20.3cm) wide.

**KO6068**

KO6069

Retractor body only.



**HAVERFIELD-SCOVILLE Retractors**

Hinged arms 6in x 8in (15.2cm x 20.1cm) wide.

**KO6070**

With 2 blades, 4in x 2in (10.2cm x 5.1cm) wide.

KO6071

Retractor body only.



**HIBBS-Type Blades**  
Angled 90°.

**KO6072**

2in x 1in  
(5.1cm x 2.5cm) wide.

**KO6077**  
3in x 1-1/2in  
(7.6cm x 3.8cm) wide.

**KO6073**  
4in x 2in  
(10.2cm x 5.1cm) wide.

**KO6078**  
3in x 2in  
(7.6cm x 5.1cm) wide.

**KO6074**  
2-1/2in x 1in  
(6.4cm x 2.5cm) wide.

**KO6079**  
3in x 2-1/2in  
(7.6cm x 6.4cm) wide.

**KO6075**  
2-1/2in x 1-1/2in  
(6.4cm x 3.8cm) wide.

**KO6080**  
3-1/2in x 1in  
(8.9cm x 2.5cm) wide.

**KO6076**  
3in x 1in  
(7.6cm x 2.5cm) wide.

**KO6081**  
4in x 1in  
(10.2cm x 2.5cm) wide.



**SCOVILLE Blade**  
4 prongs, angled 90°.

**KO6082**

1-1/2in x 1-5/8in  
(3.8cm x 4.1cm) wide.



**SCOVILLE Blunt Hooks**  
Angled 90°.

**KO6083**

Working length 2-1/4in (5.7cm).

**KO6084**  
Working length 3-1/4in (8.3cm).

**KO6085**  
With arm. Working length 2-1/2in (6.4cm).

**KO6086**  
With arm. Working length 3-1/2in (8.9cm).



**TAYLOR-Type Blades**  
4 prongs, angled 90°, 2in (5.1cm) wide.

**KO6087**

Blade length 1-7/8in (4.8cm).

**KO6088**  
Blade length 2-1/2in (6.4cm).



MEYERDING-Type Laminectomy Blades

KO6089

2-1/4in x 1in  
(5.7cm x 2.5cm) wide.

KO6090

3in x 1in  
(7.6cm x 2.5cm) wide.

KO6091

3-1/2in x 2in  
(8.9cm x 5.1cm) wide.



TAYLOR-Type Spinal Retractor Blade

KO6092

4in x 1-3/4in  
(10.2cm x 4.4cm) wide.



V. Mueller Instrument Warranty

We warranty every medical device and accessory bearing the V. Mueller brand name to be free of functional defects in workmanship and materials when used normally for its intended use. Any V. Mueller product proving to be so defective will be replaced or repaired at no charge. Repairs or modifications performed by unauthorized personnel may void all product warranties and could affect performance and efficacy of the device.

INGE Lamina Spreaders

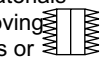

KO6092

Overall length  
6-1/2in (16.5cm).

KO6093

Without teeth.  
Overall length  
6-1/2in (16.5cm).

KO6094

Overall length  
10in (25.4cm).

KO6095

With calibrated bar.  
Overall length  
10in (25.4cm).





SCOVILLE Nerve Root Retractor  
Straight. Tip 1/4in (6.4mm) wide.



**KO6096**

Overall length  
8-3/4in (22.2cm).



LOVE Nerve Retractor  
Shank length 4in (10.2cm).



**KO6097**

Angled.

KO6098  
Angled 135°.  
Blade width 6mm.

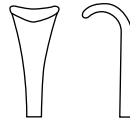

KO6099  
Straight.  
Blade 6.75mm wide.

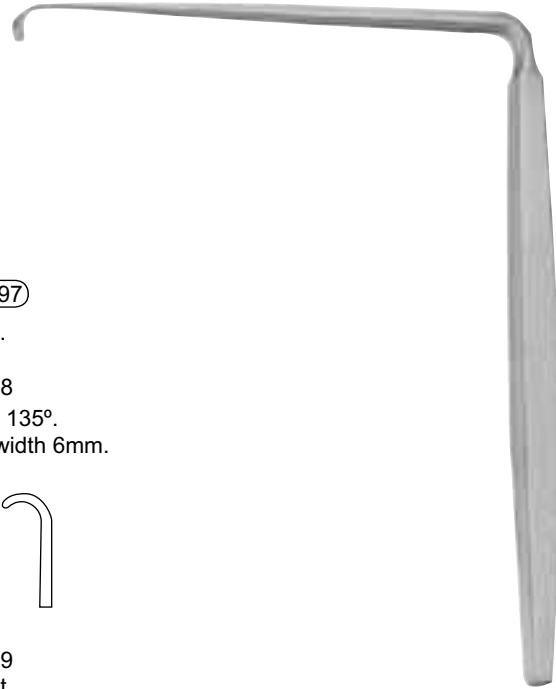

### Looking for a specific product?

When you know the catalog number or the name of the product you need, you can use the index at the end of this book to direct you to the page on which the product is described.



D'ERRICO Nerve Retractor  
Bayonet shank.  
Curved blade end,  
7.9mm wide.



KO7000

Overall length  
9in (22.9cm).



HOLSCHER Nerve Root Retractors  
Overall length 9-1/2in (24.1cm).

KO7001  
Blade 6mm wide.

KO7002

Blade 12mm wide.



SCOVILLE Nerve Root Retractor  
Angled.



KO7003

Shank length  
4-1/4in (10.8cm).

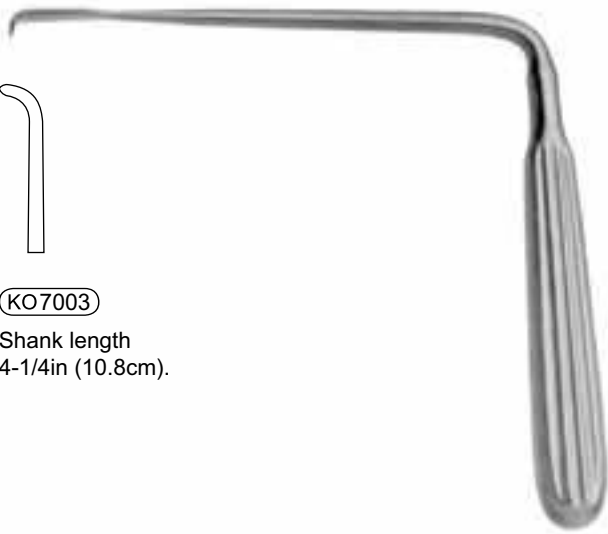

McCULLOCH Nerve Root Retractors  
Blade 6mm wide.

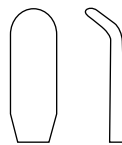

KO7004

Shaft length  
5in (12.7cm).

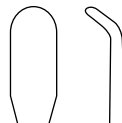

KO7005  
Extra-long shaft.  
Shaft length 6in (15.2cm).

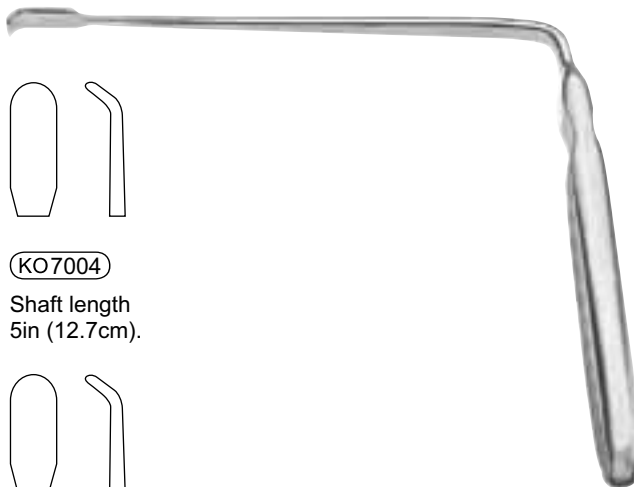

**RANEY Rongeur Forceps**  
Up-cutting bite. Shaft length 6in (15.2cm).

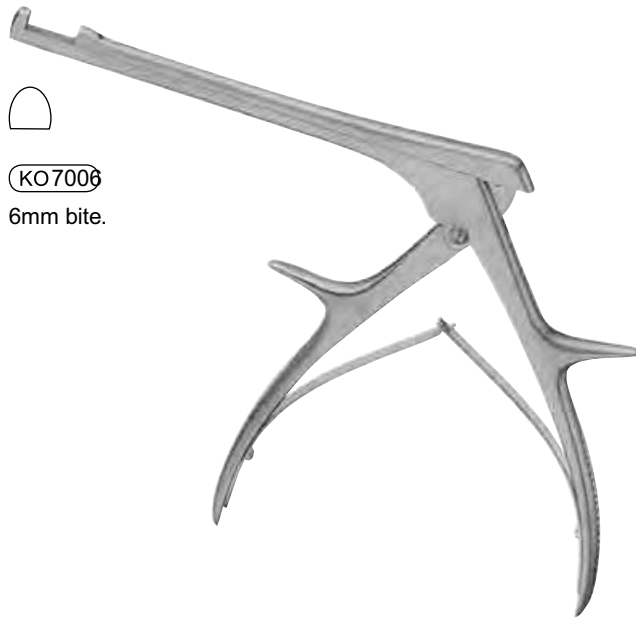

**KO7006**  
6mm bite.

**LOVE-KERRISON Rongeur Forceps**  
Shaft length 6in (15.2cm).

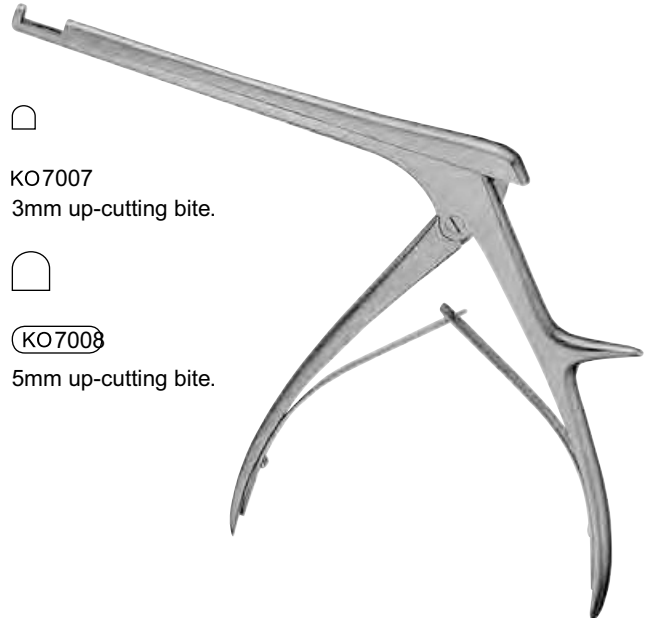

**KO7007**  
3mm up-cutting bite.



**KO7008**  
5mm up-cutting bite.

**SPURLING-KERRISON Rongeur Forceps**  
Up-cutting bite. Jaw opening 15mm.

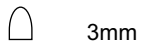
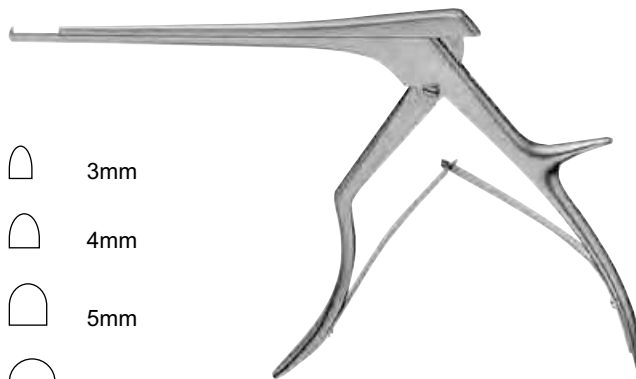

3mm

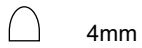

4mm

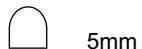

5mm



6mm

**SPURLING-KERRISON Rongeur Forceps**  
Down-cutting bite. Jaw opening 15mm.

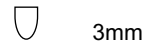
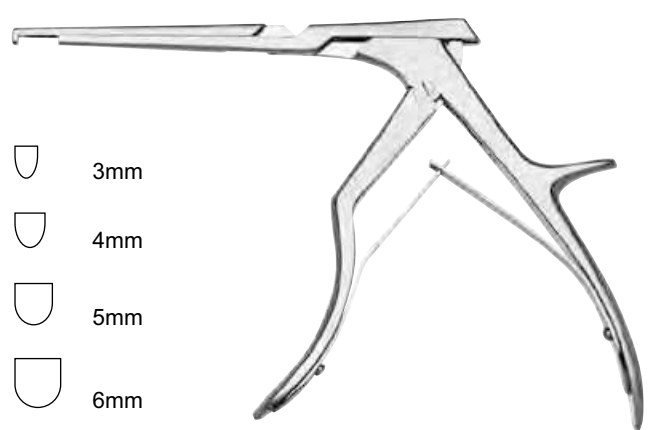

3mm

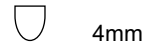

4mm

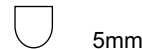

5mm



6mm

Straight	Angled 40°	Bite Size	Shaft Length
<b>KO7009</b>	NL6035	3mm	6in (15.2cm)
		4mm	6in (15.2cm)
KO7010	NL6036	5mm	6in (15.2cm)
		6mm	6in (15.2cm)
KO7011	NL6037	3mm	8in (20.3cm)
		4mm	8in (20.3cm)
KO7012	NL6038	5mm	8in (20.3cm)

Part No.	Bite Size	Shaft Length
<b>KO440</b>	3mm	6in (15.2cm)
KO440	4mm	6in (15.2cm)
KO440	5mm	6in (15.2cm)
KO440	6mm	6in (15.2cm)
KO440	3mm	8in (20.3cm)

FERRIS-SMITH-KERRISON Rongeur Forceps  
Shaft length 7in (17.8cm).

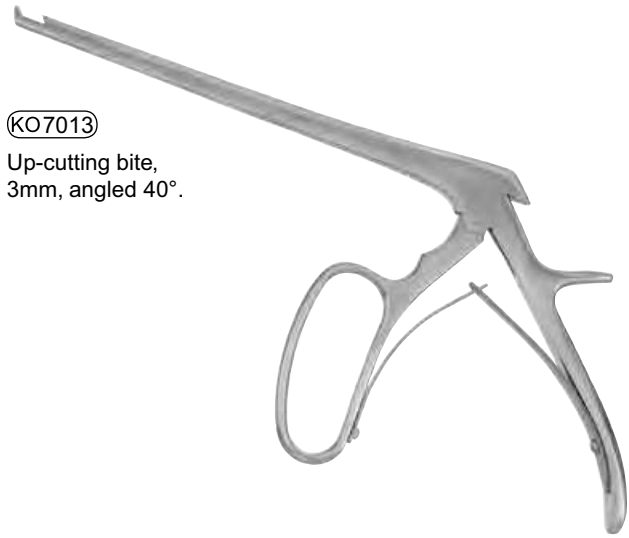

**KO7013**  
Up-cutting bite,  
3mm, angled 40°.

SPURLING-KERRISON Rongeurs  
40° up-cutting. Shaft length 8in (20.3cm).



△  
KO7014  
2mm cup.

△  
**KO7015**  
3mm cup.

DAWSON-YUHL-KERRISON Rongeur Forceps  
Working length 11in (27.9cm).

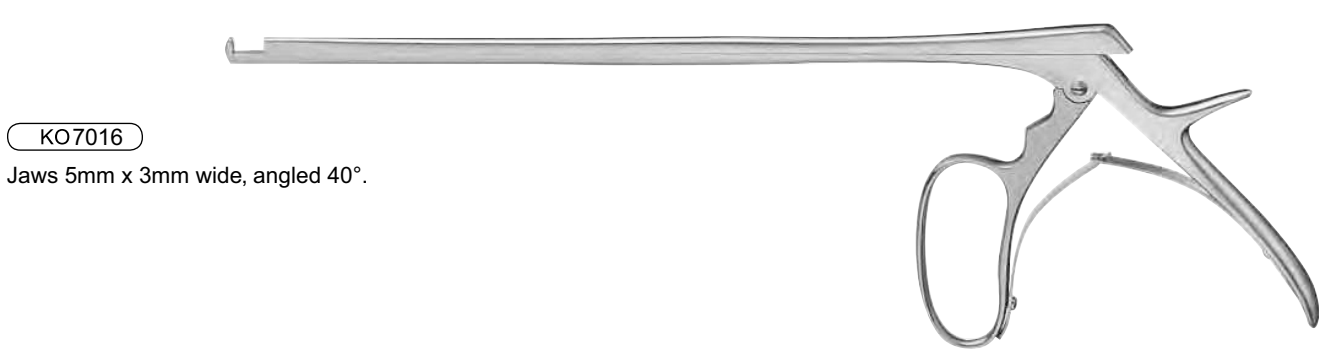

**KO7016**  
Jaws 5mm x 3mm wide, angled 40°.

FERRIS SMITH-KERRISON Rongeurs



2mm

3mm

4mm

5mm

6mm

90° Angle Up-cutting	40° Angle Up-cutting	Bite Size	Shaft Length
	NL4281-062	2mm	6in (15.2cm)
	NL4281-063	3mm	6in (15.2cm)
	NL4281-064	4mm	6in (15.2cm)
	NL4281-065	5mm	6in (15.2cm)
	NL4281-072	2mm	7in (17.8cm)
	NL4281-073	3mm	7in (17.8cm)
	NL4281-074	5mm	7in (17.8cm)
	NL4281-075	5mm	7in (17.8cm)
	NL4281-076	6mm	7in (17.8cm)
KO7017	NL4281-082	2mm	8in (20.3cm)
KO7018	NL4281-083	3mm	8in (20.3cm)
KO7019	NL4281-084	4mm	8in (20.3cm)
KO7020	NL4281-085	5mm	8in (20.3cm)
	NL4281-086	6mm	8in (20.3cm)
	NL4281-112	2mm	11in (27.9cm)
	NL4281-113	3mm	11in (27.9cm)
	NL4281-114	4mm	11in (27.9cm)
	NL4281-115	5mm	11in (27.9cm)
	NL4281-116	6mm	11in (27.9cm)

Micro Handle KERRISON Rongeurs

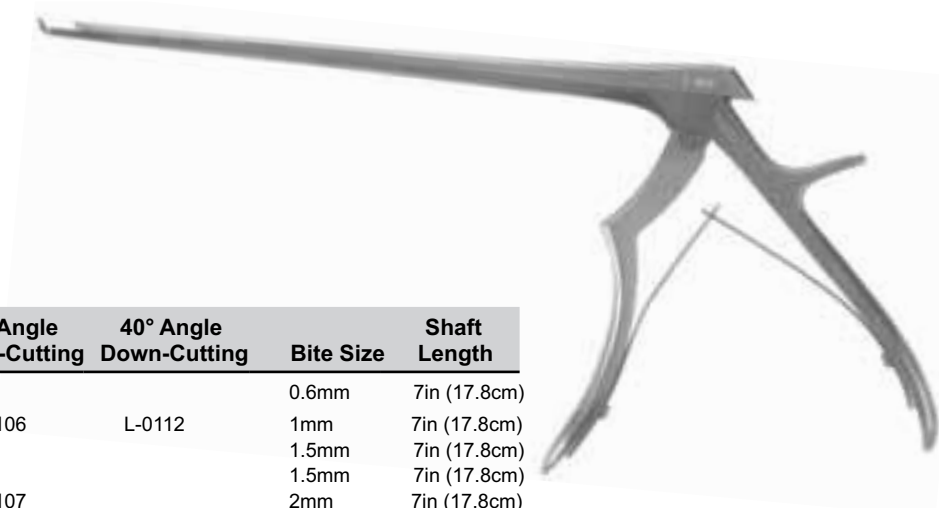

90° Angle Up-Cutting	40° Angle Up-Cutting	90° Angle Down-Cutting	40° Angle Down-Cutting	Bite Size	Shaft Length
L-0070	L-0080			0.6mm	7in (17.8cm)
L-0099		L-0106	L-0112	1mm	7in (17.8cm)
L-0071	L-0111			1.5mm	7in (17.8cm)
				1.5mm	7in (17.8cm)
L-0100		L-0107		2mm	7in (17.8cm)
L-0101		L-0108		3mm	7in (17.8cm)
L-0102				4mm	7in (17.8cm)
L-0103		L-0110		5mm	7in (17.8cm)
L-0119			L-0128	1mm	8in (20.3cm)
L-0120		L-0124		2mm	8in (20.3cm)
L-0121		L-0125		3mm	8in (20.3cm)
L-0122		L-0126		4mm	8in (20.3cm)
L-0123		L-0127		5mm	8in (20.3cm)

SPURLING-KERRISON Rongeurs

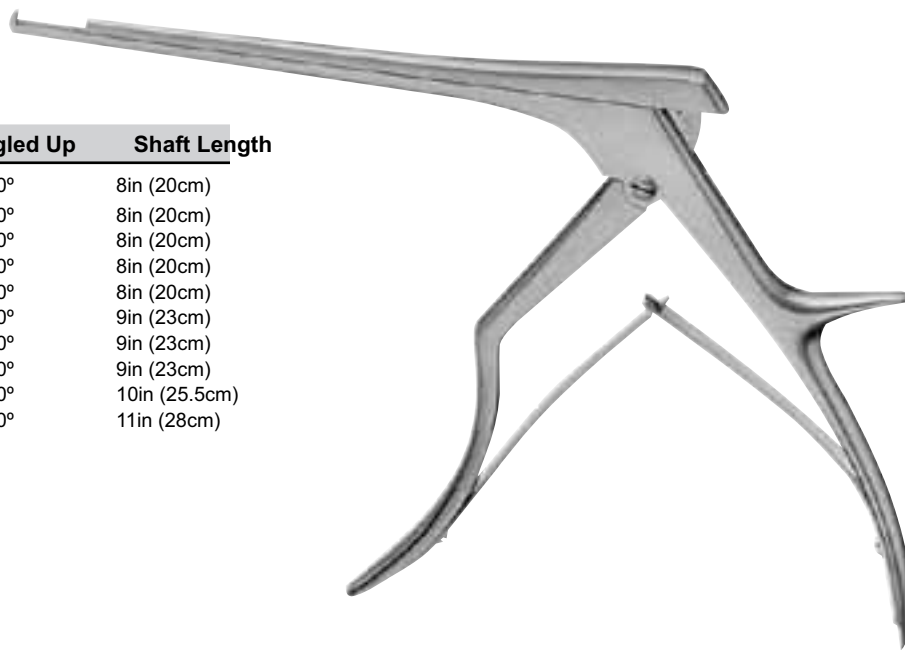

Part No.	Bite Size	Angled Up	Shaft Length
KO7021	5mm	90°	8in (20cm)
KO7022	2mm	40°	8in (20cm)
KO7023	3mm	40°	8in (20cm)
KO7024	4mm	40°	8in (20cm)
KO7025	5mm	40°	8in (20cm)
KO7026	2mm	40°	9in (23cm)
KO7027	3mm	40°	9in (23cm)
KO7028	4mm	40°	9in (23cm)
KO7029	2mm	40°	10in (25.5cm)
KO7030	4mm	40°	11in (28cm)

SPURLING Rongeurs  
Titanium Nitride spring.

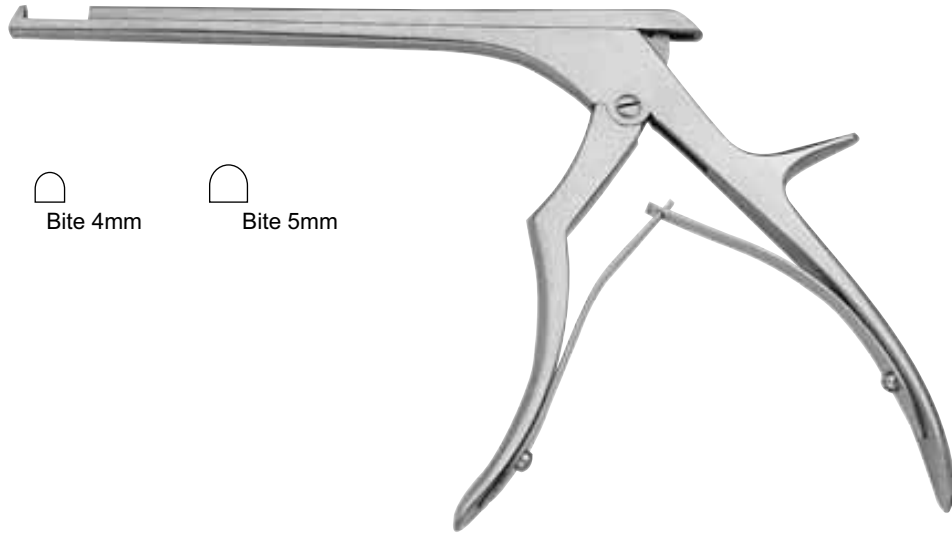

 Bite 2mm

 Bite 3mm

 Bite 4mm

 Bite 5mm

90° Angle Up-Cutting	40° Angle Up-Cutting	90° Angle Down-Cutting	Bite Size	Shaft Length
KO7032	NL4071-062	NL4072-062	2mm	6in (15.2cm)
KO7033	NL4071-063	NL4072-063	3mm	6in (15.2cm)
KO7034	NL4071-064		4mm	6in (15.2cm)
		NL4072-065	5mm	6in (15.2cm)
	NL4071-066		6mm	6in (15.2cm)
KO7035	◆ NL4071-072	NL4072-072	2mm	7in (17.8cm)
KO7036	NL4071-073	NL4072-073	3mm	7in (17.8cm)
KO7037	NL4071-074	NL4072-074	4mm	7in (17.8cm)
KO7038	NL4071-075		5mm	7in (17.8cm)
KO7039	NL4071-076		6mm	7in (17.8cm)
KO7040	◆ NL4071-082	NL4072-082	2mm	8in (20.3cm)
KO7041	◆ NL4071-083	NL4072-083	3mm	8in (20.3cm)
KO7042	◆ NL4071-084	NL4072-084	4mm	8in (20.3cm)
KO7043	NL4071-085	NL4072-085	5mm	8in (20.3cm)
KO7044	NL4071-086	NL4072-086	6mm	8in (20.3cm)
KO7045	NL4071-112		2mm	11in (27.9cm)
KO7046	NL4071-113		3mm	11in (27.9cm)
KO7047	NL4071-114		4mm	11in (27.9cm)
KO7048	NL4071-115		5mm	11in (27.9cm)
KO7049	NL4071-116		6mm	11in (27.9cm)

NEURO/SPINE  
AND ORTHOPEDIC



Grasping Forceps  
Jaws 3mm x 8mm. With tooth.



**(KO7050)**  
Overall length  
5-1/2in (14cm).

**KO7051**  
Overall length  
8in (20cm).

SPURLING Rongeur Forceps  
Alligator-type. Straight. Cup-shaped jaws 4mm x 10mm.



**(KO7052)**  
Shaft length  
5in (12.7cm).

LOVE-GRUENWALD Forceps  
Shaft length 5in (12.7cm).

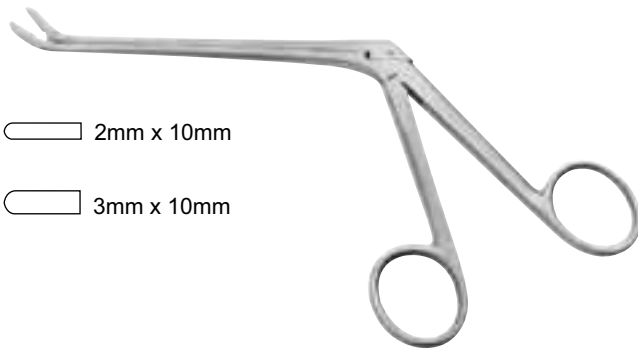

2mm x 10mm

3mm x 10mm

Part No.	Cup Size	Jaw Angle
◆ KO7053	2mm x 10mm wide	Angled up
<b>(KO7054)</b>	2mm x 10mm	Angled up
	2mm x 10mm	Angled down
◆ KO7055	3mm x 10mm wide	Straight

LOVE-GRUENWALD Pituitary Rongeur Forceps  
Shaft length 7in (17.8cm).

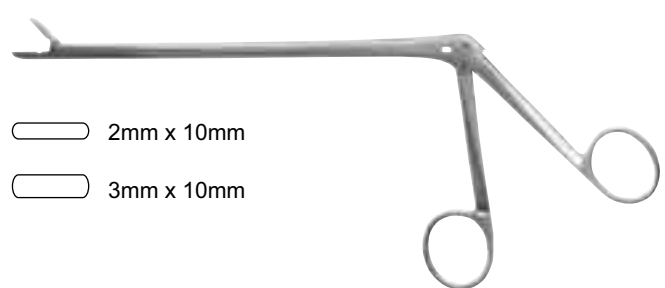

2mm x 10mm

3mm x 10mm

Part No.	Cup Size	Jaw Angle
◆ <b>(KO7057)</b>	2mm x 10mm	Straight
◆ KO7058	2mm x 10mm	Angled up
	2mm x 10mm	Angled down
◆ KO7059	3mm x 10mm	Straight
◆ KO7060	3mm x 10mm	Angled up
◆ KO7061	3mm x 10mm	Angled down

OLDBERG Pituitary Rongeur Forceps  
Cup-shaped jaws, 5mm diameter.



**(KO7056)**  
Shaft length 7in (17.8cm).

Micro Cup Forceps  
Straight. Overall length 5in (12.5cm).



**(KO7062)**  
Jaws 1mm wide.

**KO7063**  
Jaws 2mm wide.

**DECKER Rongeur Forceps**  
Overall length 6in (15.2cm).

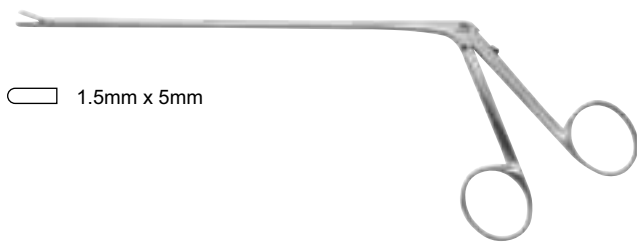

1.5mm x 5mm

Part No.	Cup Size	Jaw Angle	Shaft Length
◆ KO7064	1.5mm x 5mm	Straight	6in (15.2cm)
KO7065	1.5mm x 6mm	Straight	6in (15.2cm)
◆ <b>KO7066</b>	2mm x 6mm	Straight	6in (15.2cm)
KO7067	2mm x 6mm	Curved Left	5-1/2in (14cm)
KO7068	2mm x 6mm	Curved Right	5-1/2in (14cm)
KO7069	2mm x 6mm	Curved Up	5-1/2in (14cm)
KO7070	2mm x 6mm	Curved Down	5-1/2in (14cm)
KO7071	2mm x 6mm	Straight	7in (17.8cm)
KO7072	2mm x 6mm	Curved Up	7in (17.8cm)
KO7073	2mm x 6mm	Curved Down	7in (17.8cm)

**WILDE Rongeur Forceps**  
Fenestrated cup jaws.

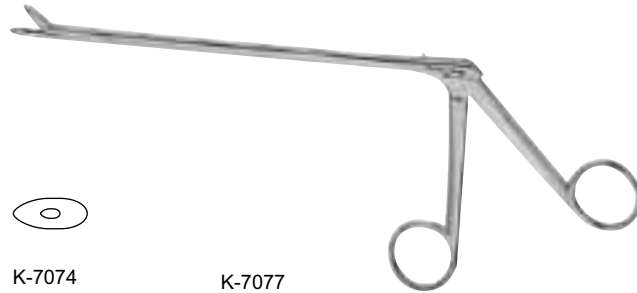

K-7074  
Straight.  
Jaws 5mm wide.  
Overall length  
6in (15cm).

K-7077  
Straight.  
Jaws 3mm wide.  
Overall length  
7in (18cm).

**KO7075**  
Straight.  
Jaws 4mm wide.  
Overall length  
7in (17.8cm).

KO7078  
Straight.  
Jaws 4mm wide.  
Overall length  
7in (18cm).

KO7079  
Straight.  
Jaws 4mm wide.  
Overall length  
9in (23cm).

KO7076  
Straight.  
Jaws 2.5mm wide.  
Overall length  
7in (18cm).

KO7078  
Straight.  
Jaws 5mm wide.  
Overall length  
7in (18cm).

KO7080  
Angled.  
Jaws 5mm wide.  
Overall length  
7in (18cm).

**CLOWARD Spinal Rongeurs**  
Serrated. Jaws 6mm x 10mm.



KO7081  
Straight.  
Overall length  
5in (12.7cm).

KO7082  
Angled up.  
Overall length  
5in (12.7cm).

KO7083  
Angled down.  
Overall length  
5in (12.7cm).

**KO7084**  
Straight.  
Overall length  
6in (15.2cm).

**FERRIS SMITH Cup Jaw Rongeur Forceps**  
Shaft length 7in (17.8cm).

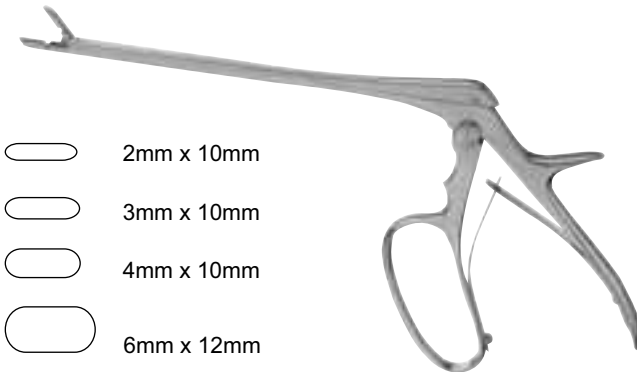

- 2mm x 10mm
- 3mm x 10mm
- 4mm x 10mm
- 6mm x 12mm

Part No.	Cup Size	Jaw Angle
<b>KO7085</b>	2mm x 10mm	Straight
KO7086	3mm x 10mm	Straight
KO7087	3mm x 10mm	Curved Down
KO7088	4mm x 10mm	Straight
KO7089	4mm x 10mm	Curved Up
KO7090	4mm x 10mm	Curved Down
◆ KO7091	6mm x 12mm	Straight
KO7092	6mm x 12mm	Curved Up

---

SPENCE Rongeur Forceps  
Alligator type. Cup-shaped jaws 4mm x 12mm.  
Shaft length 7-1/2in (19cm).



**KO7093**

Straight jaws.

KO7094  
Jaws angled down.

KO7095  
Jaws angled up.

---

PEAPOD Rongeurs  
Up-cutting jaws.



KO7092  
Jaws 1.5mm wide.  
Overall length  
5-1/2in (14cm).

◆ **KO7093**  
Jaws 2mm wide.  
Overall length  
5-1/2in (14cm).

KO7094  
Jaws 2.5mm wide.  
Overall length  
5-1/2in (14cm).

KO7095  
Jaws 3.2mm wide.  
Overall length  
5-1/2in (14cm).

KO7096  
Jaws 2mm wide.  
Overall length  
7in (18cm).

KO7097  
Jaws 2.5mm wide.  
Overall length  
7in (18cm).

KO7098  
Jaws 3.2mm wide.  
Overall length  
7in (18cm).

---

Intervertebral Disc Rongeurs  
Jaws 3mm x 10mm. Shaft length 6in (15.2cm).



**KO7099**

Straight.

KO8000  
Jaws angled up.

KO8001  
Jaws angled down.

---

*Looking for a specific product?*

When you know the catalog number or the name of the product you need, you can use the index at the end of this book to direct you to the page on which the product is described. If you do not find the specific instruments you are looking for, please contact your local V. Mueller sales representative

LOVE-GRUENWALD Rongeurs

Jaws 3mm x 10mm. Shaft length 6in (15.2cm).



Part No.	Cup Size	Shaft Length	Jaw Angle
KO8002	3mm x 10mm	7in (18cm)	Straight.
KO8003	3mm x 10mm	7in (18cm)	Up-cutting.
KO8004	3mm x 10mm	7in (18cm)	Down-cutting.
KO8005	3mm x 10mm	7in (18cm)	Straight. With teeth.
KO8006	3mm x 10mm	7in (18cm)	Up-cutting. With teeth.
KO8007	3mm x 10mm	10in (25.5cm)	Straight.
KO8008	3mm x 10mm	10in (25.5cm)	Up-cutting.
KO8009	3mm x 10mm	10in (25.5cm)	Down-cutting.
KO8010	3mm x 10mm	10in (25.5cm)	Straight. With teeth.
KO8011	4mm x 10mm	10in (25.5cm)	Straight.
KO8012	4mm x 10mm	10in (25.5cm)	Up-cutting.
KO8013	4mm x 10mm	10in (25.5cm)	Down-cutting.
KO8014	4mm x 10mm	10in (25.5cm)	Straight. With teeth.
KO8015	5mm x 10mm	10in (25.5cm)	Straight.
KO8016	5mm x 10mm	10in (25.5cm)	Up-cutting.
KO8017	5mm x 10mm	10in (25.5cm)	Down-cutting.
KO8018	5mm x 10mm	10in (25.5cm)	Straight. With teeth.

SELVERSTONE Intervertebral Disc Rongeur Forceps  
Straight. Shaft length 6in (15.2cm).



○

**KO8019**

Jaws 2mm x 3mm.

○

**KO8020**  
Jaws 2mm x 5mm.

POPPEL Intervertebral Disc Rongeurs  
Cup jaws 4mm x 7mm. Shaft length 6in (15.2cm).



○

**KO8021**

Straight.

**KO8022**  
Jaws angled up.

**KO8023**  
Jaws angled down.

**HOEN Spinal Rongeur**  
 Jaws 4mm wide. 1 x 2 Teeth.

**KO8024**

Straight. Overall length  
 5-1/2in (14cm).



**SPURLING Spinal Rongeurs**  
 Jaws 4mm x 10mm.

**KO8025**  
 Straight.  
 Overall length  
 5in (12.5cm).

**KO8026**  
 Straight.  
 Shaft length  
 6in (15.2cm).

**KO8027**  
 Jaws angled up.  
 Shaft length  
 6in (15.2cm).

**KO8028**  
 Jaws angled down.  
 Shaft length  
 6in (15.2cm).

◆ **KO8029**

Straight.  
 Shaft length  
 7in (17.8cm).

**KO8030**  
 Jaws angled up.  
 Shaft length  
 7in (17.8cm).

**KO8031**  
 Jaws angled down.  
 Shaft length  
 7in (17.8cm).

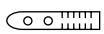
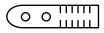
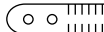
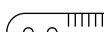

**Intervertebral Disc Rongeurs**  
 Double fenestrated with back of cup serrated. Shaft length 7-1/4in (18.5cm).

-  2mm x 12mm
-  3mm x 12mm
-  4mm x 14mm
-  5mm x 14mm



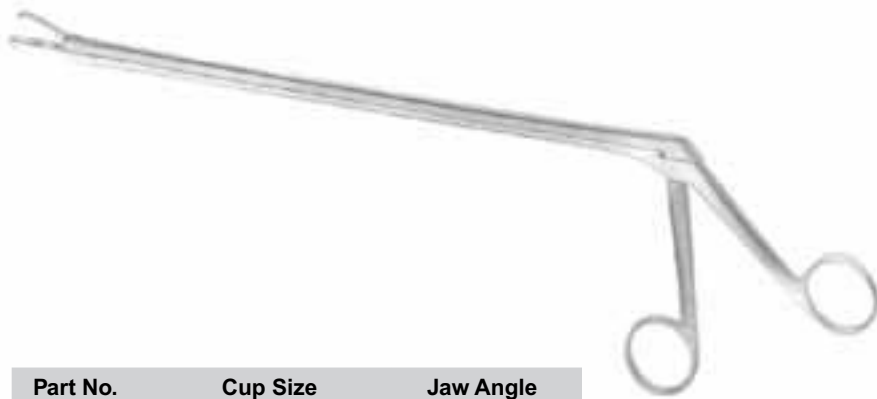

Part No.	Cup Size	Jaw Angle
<b>KO8032</b>	2mm x 12mm	Straight
KO8033	3mm x 12mm	Straight
KO8034	3mm x 12mm	Curved Up
KO8035	3mm x 12mm	Curved Down
KO8036	4mm x 14mm	Straight
KO8037	4mm x 14mm	Curved Up
KO8038	4mm x 14mm	Curved Down
KO8039	5mm x 14mm	Straight
KO8040	5mm x 14mm	Curved Up

IVD Rongeurs  
Overall length 12in (30cm).



Part No.	Cup Size	Jaw Angle
KO8041	2mm x 10mm	Straight
KO8042	2mm x 10mm	Angled up
KO8043	3mm x 10mm	Straight
KO8044	3mm x 10mm	Angled up
KO8045	3mm x 10mm	Angled down
KO8046	4mm x 10mm	Straight
KO8047	4mm x 10mm	Angled up
KO8048	4mm x 10mm	Angled down
KO8049	5mm x 10mm	Straight
KO8050	5mm x 10mm	Angled up

CUSHING Spinal Rongeurs

-  1.5mm x 10mm
-  2mm x 10mm



Part No.	Cup Size	Jaw Angle	Shaft Length
◆ KO8051	1.5mm x 10mm	Straight	7in (17.8cm)
KO8052	1.5mm x 10mm	Angled up	7in (17.8cm)
KO8053	1.5mm x 10mm	Angled down	7in (17.8cm)
KO8054	1.5mm x 10mm	Angled up	9in (23cm)
KO8055	1.5mm x 10mm	Angled down	9in (23cm)
○ KO8056	2mm x 10mm	Straight	6in (15.2cm)
KO8057	2mm x 10mm	Angled up	6in (15.2cm)
KO8058	2mm x 10mm	Angled down	6in (15.2cm)
KO8059	2mm x 10mm	Straight	7in (17.8cm)
KO8060	2mm x 10mm	Angled up	7in (17.8cm)
KO8061	2mm x 10mm	Angled down	7in (17.8cm)
KO8062	2mm x 10mm	Straight	7in (17.8cm)
KO8063	2mm x 10mm	Angled up. With teeth	7in (17.8cm)
KO8064	2mm x 10mm	Angled down. With teeth	7in (17.8cm)

Chroma-Line<sup>®</sup> Spinal Rongeurs  
Single-ring handle.



Straight	Up-cutting	Down-cutting	Shaft length	Cup Size	Color
U-0700	U-0701	U-0702	7in (17.8)	1.5mm cup.	Red
U-0710	U-0711	U-0712	7in (17.8)	2mm cup.	Blue
U-0720	U-0721	U-0722	7in (17.8)	3mm cup.	Violet
U-0730	U-0731	U-0732	7in (17.8)	4mm cup.	Turquoise
U-0705	U-0706	U-0707	9in (22.9)	1.5mm cup.	Red
U-0715	U-0716	U-0717	9in (22.9)	2mm cup.	Blue
U-0725	U-0726	U-0727	9in (22.9)	3mm cup.	Violet
U-0735	U-0736	U-0737	9in (22.9)	4mm cup.	Turquoise

Chroma-Line<sup>®</sup> Spinal Rongeurs  
Double-ring handle.



Straight	Up-cutting	Down-cutting	Shaft length	Cup Size	Color
U-0800	U-0801	U-0802	7in (17.8cm)	1.5mm	Red
U-0810	U-0811	U-0812	7in (17.8cm)	2mm	Blue
U-0820	U-0821	U-0822	7in (17.8cm)	3mm	Violet
U-0830	U-0831	U-0832	7in (17.8cm)	4mm	Turquoise
U-0805	U-0806	U-0807	9in (22.9cm)	1.5mm	Red
U-0815	U-0816	U-0817	9in (22.9cm)	2mm	Blue
U-0825	U-0826	U-0827	9in (22.9cm)	3mm	Violet
U-0835	U-0836	U-0837	9in (22.9cm)	4mm	Turquoise



### Customer Support

Our highly trained, centralized V. Mueller customer support team is available to take your calls from 7:00 a.m. to 6:00 p.m. (CST), M-F. This group is dedicated to providing a full range of support services, including:

- Order placement
- Order inquiries
- Delivery information
- Product information
- Pricing inquiries

ADSON Laminectomy Chisel  
Blade 1/2in (1.3cm) wide.  
Hollow handle.

**KO8065**

Overall length 7-1/4in (18.4cm).



ROCHESTER Elevator and Dissector  
1/8in (3mm) wide.

**KO8066**

Overall length 9in (22.9cm).



DAWSON-YUHL Key Type Elevators  
Overall length  
11in (27.9cm).

**KO8067**

Blade 3/4in (1.9cm) wide.

KO8068  
Blade 1in (2.5cm) wide.



NEURO/SPINE  
AND ORTHOPEDIC

**RANEY Stirrup-Loop Currettes**  
Cuts on both sides.



**KO8069**

Style 1, slightly curved.  
Overall length  
9-1/2in (24.1cm).

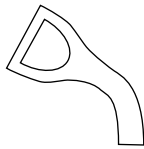

**KO8071**

Style 3, substantially curved.  
Overall length  
9-1/4in (23.5cm).

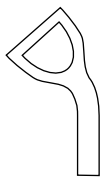

**KO8070**

Style 2, moderately curved.  
Overall length  
9-1/4in (23.5cm).



**SCOVILLE Ruptured Disc Currettes**  
4mm x 10mm cup.  
Overall length  
10in (25.4cm).



**KO8072**

Straight.

**KO8073**  
Angled 45°.

**KO8074**  
Angled down.

**KO8075**  
Horizontal.



**Cone Ring Currettes**  
Aluminum handle. Overall length 9in (22.9cm).

**KO8076**

Straight. 4mm diameter.

**KO8077**  
Straight. 7mm diameter.

**KO8078**  
Straight. 9.5mm diameter.

**KO8079**  
Angled. 4mm diameter.

**KO8080**  
Angled. 7mm diameter.

**KO8081**  
Angled. 9.5mm diameter.



**DAWSON-YUHL Cone Currettes**  
Overall length 11in (27.9cm).

**KO8082**

Straight. 4mm diameter.

**KO8083**  
Straight. 7mm diameter.

**KO8084**  
Angled. 4mm diameter.

**KO8085**  
Angled. 7mm diameter.



Chroma-Line<sup>®</sup> Micro Spinal Currettes

Straight. Round handle design enhances range of motion. Overall length 9-1/4in (23.5cm).



U-2190

U-2252



Straight	Angled	Reverse Angled	Cup Size	Color
U-2175	U-2190	U-2205	000000	Red
U-2176	U-2191	U-2206	000000	Silver
U-2177	U-2192	U-2207	00000	Violet
U-2178	U-2193	U-2208	000	Turquoise
U-2179	U-2194	U-2209	00	Gold
U-2180	U-2195	U-2210	0	Green
U-2181	U-2196	U-2211	1	Orange
U-2182	U-2197	U-2212	2	Blue

Straight Up	Straight Down	Angled Up	Angled Down	Reverse Angled Up	Reverse Angled Down	Cup Size	Color
U-2220	U-2235	U-2250			U-2295	000000	Red
U-2221	U-2236	U-2251	U-2266	U-2281	U-2296	000000	Silver
U-2222	U-2237	U-2252	U-2267	U-2282	U-2297	0000	Violet
U-2223	U-2238	U-2253	U-2268	U-2283	U-2298	000	Turquoise
U-2224	U-2239	U-2254	U-2269	U-2284	U-2299	00	Gold
U-2225	U-2240	U-2255	U-2270	U-2285	U-2300	0	Green
U-2226	U-2241	U-2256		U-2286	U-2301	1	Orange
U-2227		U-2257		U-2287	U-2302	2	Blue

NEURO/SPINE  
AND ORTHOPEDIC

Chroma-Line<sup>®</sup> Upper Spinal Currettes

Overall length 10in (25.4cm).



Straight	Angled 90°	Reverse Angled	Angled	Cup Size	Color
KO8086	U-0186	U-0162	U-0150	000000	Red
KO8087	U-0187	U-0163	U-0151	000000	Silver
◆KO8088	U-0188	◆U-0164	U-0152	0000	Violet
KO8089	U-0189	◆U-0165	U-0153	000	Turquoise
◆KO8090	U-0190	◆U-0166	U-0154	00	Gold
KO8091	U-0191	◆U-0167	U-0155	0	Green
KO8092	U-0192	U-0168	U-0156	1	Orange
KO8093	U-0193	U-0169	U-0157	2	Blue
KO8094	U-0194	U-0170	U-0158	3	Gray
KO8095	U-0195	U-0171	U-0159	4	Black
KO8096	U-0196	U-0172	U-0160	5	Black
KO8097	U-0197	U-0173	U-0161	6	Black



Chroma-Line<sup>®</sup> Lower Spine Curettes  
 Overall length 13-3/4in (34.9cm).



Straight	Angled	Reverse Angled	Cup Size	Color
U-0224	U-0212	U-0200	000000	Red
U-0225	U-0213	U-0201	00000	Silver
U-0226	U-0214	U-0202	0000	Violet
U-0227	U-0215	U-0203	000	Turquoise
<b>U-0228</b>	U-0216	U-0204	00	Gold
U-0229	U-0217	U-0205	0	Green
U-0230	U-0218	U-0206	1	Orange
U-0231	U-0219	U-0207	2	Blue
U-0232	U-0220	U-0208	3	Gray
U-0233	U-0221	U-0209	4	Black
U-0234	U-0222	U-0210	5	Black
U-0235	U-0223	U-0211	6	Black



Curette Sterilization and Storage Racks  
 Holds 12.

**KO8098**

For 9in and 10in (25.4cm) curettes.

KO8099

For 13-3/4in (34.9cm) curettes.





**SHADOW-LINE<sup>®</sup> Spinal Retractor and Distraction Set**

The Shadow-Line<sup>®</sup> Spinal Retractor System provides operative versatility by combining unilateral and bilateral retraction in a single system.

- Patented side-loading blade attachment design facilitates blade engagement and ensures muscle and tissue retraction.
- Radiolucent aluminum retractor blades allow for intra-operative X-ray and fluoroscopic visualization.
- Shadow-Line<sup>®</sup> color-coding system with color-coded depth gauge simplifies blade selection, optimizing efficiency.
- Blade attachment design allows for full interchangeability with the Versa-Trac<sup>®</sup> retractor system components, expanding retraction possibilities and indications.
- Blade length and width configurations, as well as low-profile, double-hinged retractor frame design, easily adapt to a wide range of procedures.
- Set components can be ordered individually.

SHADOW-LINE® Spinal Retractor and Set

◆ KO9000

Set includes the following:

Cat. No.	Description	Set Quantity
KO9001	Depth gauge. Color-coded.	1 ea
KO9002	Locking retractor handle. Side-loading.	2 ea
KO9003	Step-down transverse retractor frame. Double-hinged. Side-loading.	1 ea
KO9004	Transverse retractor frame. Double-hinged. Side-loading. Opening 120mm.	1 ea
KO9005	Instrument case.	1 ea
KO9006	Tissue blade. Blunt. Blade 30mm x 23mm wide. Silver.	2 ea
KO9007	Tissue blade. Blunt. Blade 35mm x 23mm wide. Blue.	2 ea
KO9008	Tissue blade. Blunt. Blade 40mm x 23mm wide. Red.	2 ea
KO9009	Tissue blade. Blunt. Blade 45mm x 23mm wide. Green.	2 ea
KO9010	Tissue blade. Blunt. Blade 50mm x 23mm wide. Violet.	2 ea
KO9011	Tissue blade. Blunt. Blade 55mm x 23mm wide. Black.	2 ea
KO9012	Tissue blade. Blunt. Blade 60mm x 23mm wide. Gold.	2 ea
KO9013	Tissue blade. Blunt. Blade 65mm x 23mm wide. Navy.	2 ea
KO9014	Tissue blade. Blunt. Blade 70mm x 23mm wide. Light green.	2 ea
KO9015	Tissue blade. Blunt. Blade 75mm x 75mm wide. Orange.	2 ea
KO9016	Narrow muscle blade. Short teeth. Blade 35mm x 14mm wide. Blue.	2 ea
KO9017	Narrow muscle blade. Short teeth. Blade 40mm x 14mm wide. Red.	2 ea
KO9018	Narrow muscle blade. Short teeth. Blade 45mm x 14mm wide. Green.	2 ea
KO9019	Narrow muscle blade. Short teeth. Blade 50mm x 14mm wide. Violet.	2 ea
KO9020	Narrow muscle blade. Short teeth. Blade 55mm x 14mm wide. Black.	2 ea
KO9021	Narrow muscle blade. Short teeth. Blade 60mm x 14mm wide. Gold.	2 ea
KO9022	Lateral muscle blade. Short teeth. Blade 30mm x 23mm wide. Silver.	1 ea
KO9023	Lateral muscle blade. Short teeth. Blade 35mm x 23mm wide. Blue.	1 ea
KO9024	Lateral muscle blade. Short teeth. Blade 40mm x 23mm wide. Red.	1 ea
KO9025	Lateral muscle blade. Short teeth. Blade 45mm x 23mm wide. Green.	1 ea
KO9026	Lateral muscle blade. Short teeth. Blade 50mm x 23mm wide. Violet.	1 ea
KO9027	Lateral muscle blade. Short teeth. Blade 55mm x 23mm wide. Black.	1 ea
KO9028	Lateral muscle blade. Short teeth. Blade 60mm x 23mm wide. Gold.	1 ea
KO9029	Lateral muscle blade. Short teeth. Blade 65mm x 23mm wide. Navy.	1 ea
KO9030	Median muscle blade. Long teeth. Blade 30mm x 23mm wide. Silver.	1 ea
KO9030	Median muscle blade. Long teeth. Blade 35mm x 23mm wide. Blue.	1 ea
KO9031	Median muscle blade. Long teeth. Blade 40mm x 23mm wide. Red.	1 ea
KO9032	Median muscle blade. Long teeth. Blade 45mm x 23mm wide. Green.	1 ea
KO9033	Median muscle blade. Long teeth. Blade 50mm x 23mm wide. Violet.	1 ea
KO9034	Median muscle blade. Long teeth. Blade 55mm x 23mm wide. Black.	1 ea
KO9035	Median muscle blade. Long teeth. Blade 60mm x 23mm wide. Gold.	1 ea
KO9036	Median muscle blade. Long teeth. Blade 65mm x 23mm wide. Navy.	1 ea
KO9037	Narrow tissue blade. Blunt. Blade 35mm x 14mm wide. Blue.	2 ea
KO9038	Narrow tissue blade. Blunt. Blade 40mm x 14mm wide. Red.	2 ea
KO9039	Narrow tissue blade. Blunt. Blade 45mm x 14mm wide. Green.	2 ea
KO9040	Narrow tissue blade. Blunt. Blade 50mm x 14mm wide. Violet.	2 ea
KO9041	Narrow tissue blade. Blunt. Blade 55mm x 14mm wide. Black.	2 ea
KO9042	Narrow tissue blade. Blunt. Blade 60mm x 14mm wide. Gold.	2 ea



SHADOW-LINE® Side Loading Retractor Handle

(KO9043)

Blade length 60mm.



SHADOW-LINE® Transverse Retractors  
Side-loading. Double-hinged.

(KO9044)

Opening 120mm.

KO9045  
Multi-level. Opening 150mm.

KO9046  
Multi-level. Opening 200mm.



SHADOW-LINE® Step-Down Transverse Retractor  
Side-loading. Double-hinged.

(KO9047)

Opening 120mm.



SHADOW-LINE® Longitudinal Retractor  
Top-loading. Double-hinged.

(KO9048)



SHADOW-LINE® Transverse Retractors  
Top-Loading. Double-hinged.

(KO9049)

Opening 120mm.

KO9050  
Opening 150mm.

KO9051  
Opening 200mm.





SHADOW-LINE® Distractors

KO9052  
Right. Opening 100mm.

KO9053  
Right. Opening 120mm.

(KO9054)  
Right. Opening 150mm.

KO9055  
Left. Opening 100mm.

KO9056  
Left. Opening 120mm.

(KO9057)  
Left. Opening 150mm.



SHADOW-LINE® Bone Graft  
Holder  
Overall length  
8-1/2in (21.6cm).

◆ (KO9058)



SHADOW-LINE® Left Drill Guide  
For Distractors S-0078, S-0079, S-0086.

(KO9059)



SHADOW-LINE® Right Drill Guide  
For Distractors S-0087, S-0104, S-0109.

(KO9060)



SHADOW-LINE® Caliper

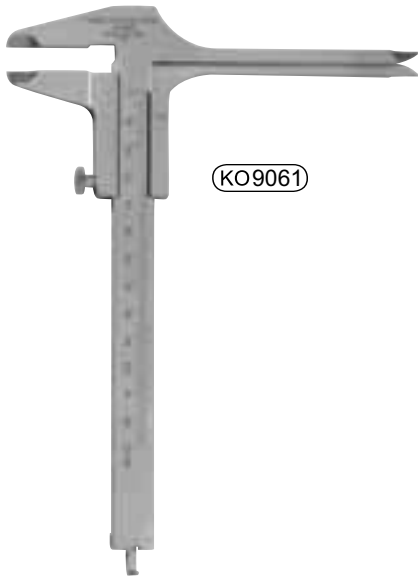

(KO9061)

SHADOW-LINE® Distraction Screwdriver

(KO9062)



SHADOW-LINE® Twist Drill  
Cutting bit diameter 1.7mm.

(KO9063)



SHADOW-LINE® Bone Removal  
Forceps

◆ (KO9064)

Tip 7mm.

KO9065  
Tip 10mm.



Distraction Screws  
Packaged sterile. 5 per box.

(KO9066)

12mm. Sterile.

KO9067  
14mm. Sterile.

KO9068  
16mm. Sterile.

KO9069  
18mm. Sterile.



Distraction Screws  
Packaged non-sterile individually.

KO9070  
12mm. Non-sterile.

KO9071  
14mm. Non-sterile.

KO9072  
16mm. Non-sterile.

KO9073  
18mm. Non-sterile.

SHADOW-LINE® Bone Tamps

KO9074

3mm diameter.

KO9075

5mm diameter.

KO9076

8mm diameter.



V. Mueller Instrument Detergents

To assist with the care and handling of your instruments, CareFusion offers you a full line of cleaning and decontamination products detailed in the Genesis Sterilization Containers and Instrument Processing Supplies section of this armamentarium.

SHADOW-LINE® Spinal Retractor System Cases  
Holds retractor and distraction bodies.

KO9077

For SHADOW-LINE® set Z-0102. Includes lid, upper insert, middle insert and base.

KO9078

Lid.

KO9079

Upper insert.

KO9080

Middle insert.

KO9081

Base.





Z-0102RC



Z-0102DG

SHADOW-LINE® Retraction/Distractor Platforms and Sets

Part No.	Description
Z-0102ARD	Step-down Platform. DIN Size.
Z-0102ARG	Step-down Platform with GENESIS™ container CD3-5B.
Z-0102DC	Distractor set. DIN Sized Z-Case.
Z-0102DD	Distractor set with GENESIS™ container CD3-5B.
Z-0102DDP	Distractor Platform. Single level. DIN Size.
Z-0102DG	DISTRACTOR SET WITH GENESIS™ CONTAINER CD3-5B.
Z-0102DGP	Distractor Platform. Single level. For CD3-5B.
Z-0102RC	RETRACTION SET. DIN SIZED Z-CASE.
Z-0102RD	Retraction Platform. DIN Size Z-Case.
Z-0102RDP	Retraction Platform. Two levels. DIN Size Z-Case.
Z-0102RG	Retraction set with GENESIS™ container CD3-5B.
Z-0102RGP	Retraction Platform. Two levels. For CD3-5B.
Z-CASE	Perforated Sterilization case. DIN Size.

SHADOW-LINE® Perforated Sterilization Case



Z-CASE  
DIN Size

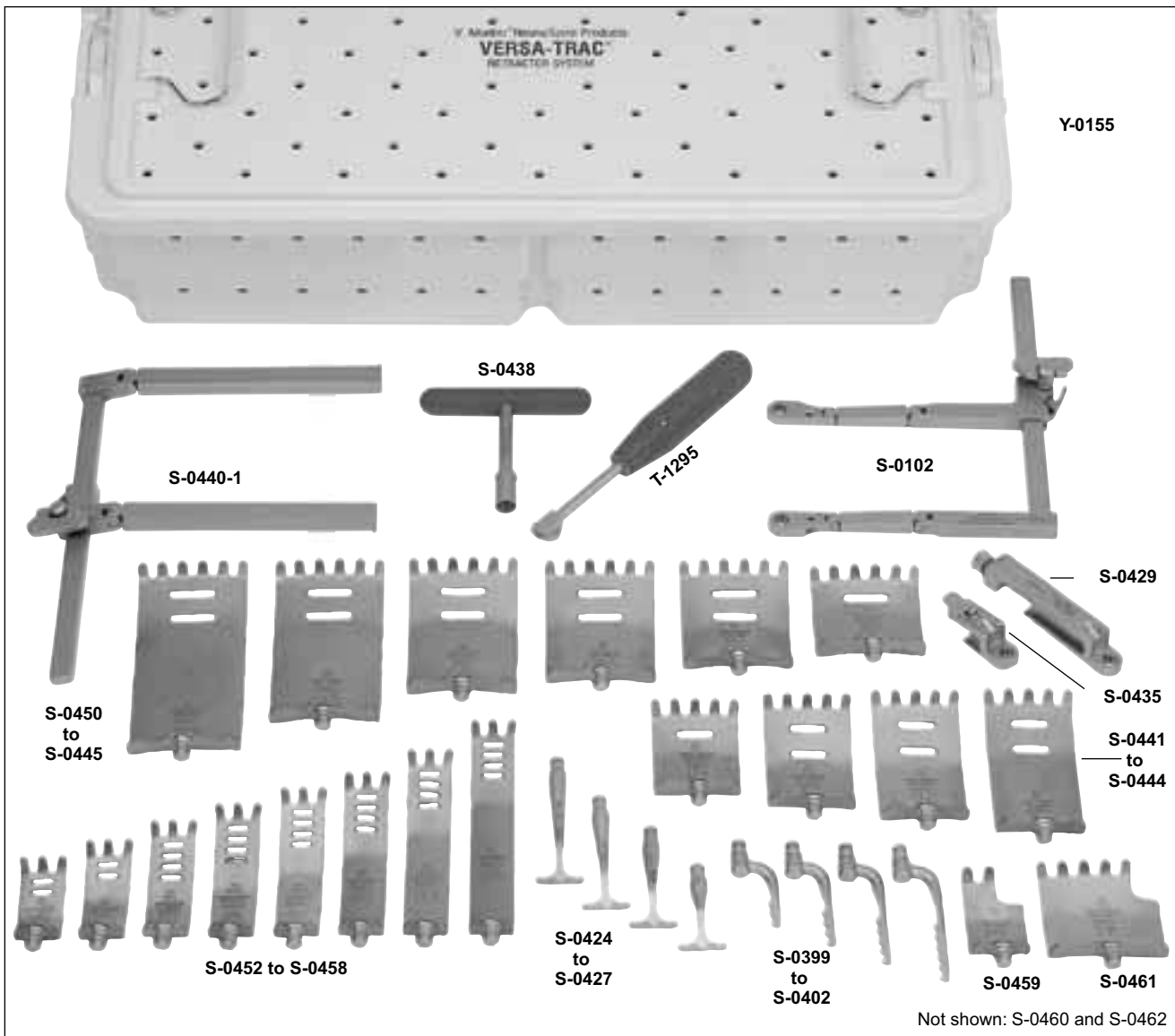

The Versa-Trac® Lumbar Retractor System provides operative versatility – combining unilateral, bilateral, micro and macro lumbar spine retraction in a single system. Translucent titanium blades allow for intra-operative X-ray or fluoroscopic visualization. Blade attachment design allows full interchangeability with the Shadow-Line® Spine Retractor System components, expanding retraction possibilities and indications.

The Versa-Trac® Lumbar Retractor System is available in a Master Set (catalog number Z-0150) and a Basic Set (catalog number Z-0151). Both sets are offered with the standard 15° blade design. The Master Set includes common items used to perform spine procedures from T1 through S1.



**VERSA-TRAC® Lumbar Retractor Master Set**  
Set includes the following:

**KO9082**

Cat. No.	Description	Set Quantity
	VERSA-TRAC® SCOVILLE Retractor Frame Double-hinged.	
S-0102	Opening 200mm.	
	VERSA-TRAC® Hooks Sharp. Multiple teeth.	
S-0399	Length 40mm.	
S-0400	Length 50mm.	
S-0401	Length 60mm.	
S-0402	Length 70mm.	
	VERSA-TRA1C® Lumbar Spine T-Bars 25mm wide.	
S-0424	Length 40mm.	
S-0425	Length 50mm.	
S-0426	Length 60mm.	
S-0427	Length 70mm.	
	VERSA-TRAC® Titanium Muscle Blades Angled 15°. With teeth. Blade 45mm wide.	
S-0441	Blade length 50mm.	
S-0442	Blade length 60mm.	
S-0443	Blade length 70mm.	
S-0444	Blade length 80mm.	

**titanium**

**VERSA-TRAC® Titanium Wide Muscle Blades**  
Angled 15°. With teeth.

S-0445	Blade 60 x 50mm wide.
S-0446	Blade 60mm x 60mm wide.
S-0447	Blade 70mm x 60mm wide.
S-0448	Blade 80mm x 60mm wide.
S-0449	Blade 100mm x 60mm wide.
S-0450	Blade 120mm x 60mm wide.

**titanium**

**VERSA-TRAC® Titanium Wide Sacral Blades**  
Angled 15°. With teeth.

S-0459	Blade 45mm x 60mm wide. Left.
S-0462	Blade 40mm x 30mm wide. Left.
S-0460	Blade 40mm x 30mm wide. Right.
S-0461	Blade 45mm x 60mm wide. Right.

**titanium**

**VERSA-TRAC® Lumbar Retractor Basic Set**  
Set includes the following:

**KO9083**

Cat. No.	Description	Set Quantity
S-0435	Lumbar retractor blade holder. Side-loading.	6 each
S-0429	Adjustable lumbar retractor blade holder. Side-loading.	4 each
S-0438	Lumbar retractor T-handle.	1 each
S-0440-1	Lumbar retractor frame. Holds multiple blades. Opening 225mm.	1 each
T-1295	Locking retractor handle. Side-loading.	2 each
Y-0155	Instrument case.	1 each
S-0452	Titanium narrow muscle blade. Angled 15°. With teeth. Blade 35mm x 23mm wide.	4 each
S-0453	Titanium narrow muscle blade. Angled 15°. With teeth. Blade 45mm x 23mm wide.	4 each
S-0454	Titanium narrow muscle blade. Angled 15°. With teeth. Blade 55mm x 23mm wide.	4 each
S-0451	Titanium narrow muscle blade. Angled 15°. With teeth. Blade 65mm x 23mm wide.	4 each
S-0455	Titanium narrow muscle blade. Angled 15°. With teeth. Blade 75mm x 23mm wide.	4 each
S-0456	Titanium narrow muscle blade. Angled 15°. With teeth. Blade 85mm x 23mm wide.	4 each
S-0457	Titanium narrow muscle blade. Angled 15°. With teeth. Blade 100mm x 23mm wide.	4 each
S-0458	Titanium narrow muscle blade. Angled 15°. With teeth. Blade 120mm x 23mm wide.	4 each

**titanium**

**VERSA-TRAC® Titanium Narrow Muscle Blades**  
Angled 15°. With teeth. Blade 23 mm wide.

S-0452	Blade length 35mm.
S-0453	Blade length 45mm.
S-0454	Blade length 55mm.
S-0451	Blade length 65mm.
S-0455	Blade length 75mm.
S-0456	Blade length 85mm.
S-0457	Blade length 100mm.
S-0458	Blade length 120mm.

VERSA-TRAC® Titanium Muscle Blades  
Angled 30°. With teeth. Blade 45mm wide.

Cat. No.	Description
S-1441	Blade length 50mm.
S-1442	Blade length 60mm.
S-1443	Blade length 70mm.
S-1444	Blade length 80mm.

**titanium**

VERSA-TRAC® Titanium Wide Muscle Blades  
Angled 30°. With teeth.

S-1445	Blade 50mm x 60mm wide.
S-1446	Blade 60mm x 60mm wide.
S-1447	Blade 60mm x 70mm wide.
S-1448	Blade 60mm x 80mm wide.
S-1449	Blade 60mm x 100mm wide.
S-1450	Blade 60mm x 120mm wide.

**titanium**

VERSA-TRAC® Titanium Narrow Muscle Blades  
Angled 30°. With teeth. Blades 23mm wide.

S-1452	Blade length 35mm.
S-1453	Blade length 45mm.
S-1454	Blade length 55mm.
S-1451	Blade length 65mm.
S-1455	Blade length 75mm.
S-1456	Blade length 85mm.
S-1457	Blade length 100mm.
S-1458	Blade length 120mm.

**titanium**

VERSA-TRAC® Hooks  
Sharp.

(KO9091)	Length 40mm.
KO9092	Length 50mm.
KO9093	Length 60mm.
KO9094	Length 70mm.
KO9095	Length 80mm.
KO9096	Length 90mm.
KO9097	Length 100mm.
KO9098	Length 120mm.



VERSA-TRAC® Hooks  
Offset. Sharp.

(KO9099)	Length 30mm.
KO10000	Length 40mm.
KO10001	Length 50mm.
KO10002	Length 60mm.
KO10003	Length 75mm.
KO10004	Length 85mm.
KO10005	Length 95mm.
KO10006	Length 115mm.



VERSA-TRAC® Multiple-Toothed  
Hooks

(KO9084)	Length 25mm.
KO9085	Length 30mm.
KO9086	Length 40mm.
KO9087	Length 50mm.
KO9088	Length 60mm.
KO9089	Length 70mm.
KO9090	Length 80mm.



NEURO/SPINE  
AND ORTHOPEDIC



---

VERSA-TRAC® Lumbar Retractor  
Frame  
Holds multiple blades.

KO10007

Opening 225mm.

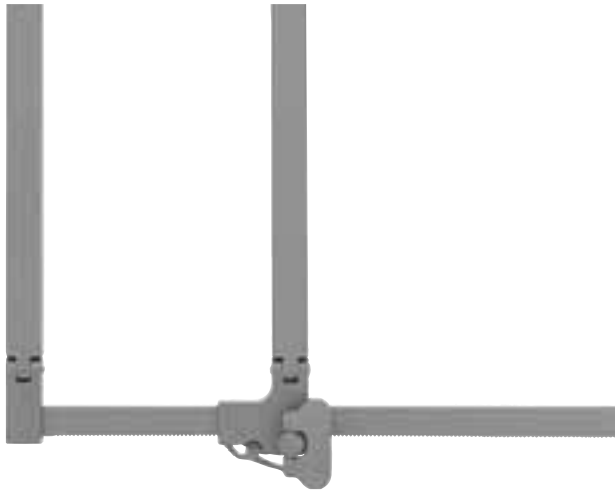

---

To learn how the IMPRESS system can help improve process performance, reduce immediate-use steam sterilization, decrease case delays, and improve patient care by monitoring instrument flow within your facility, contact your V. Mueller sales representative.

---

VERSA-TRAC® Retractor Cases  
For Lumbar Retractor Set Z-0150.

KO10008

Lid.

KO10009

Upper insert.

KO10010

Middle insert.

KO10011

Lower insert.

KO10012

Base.



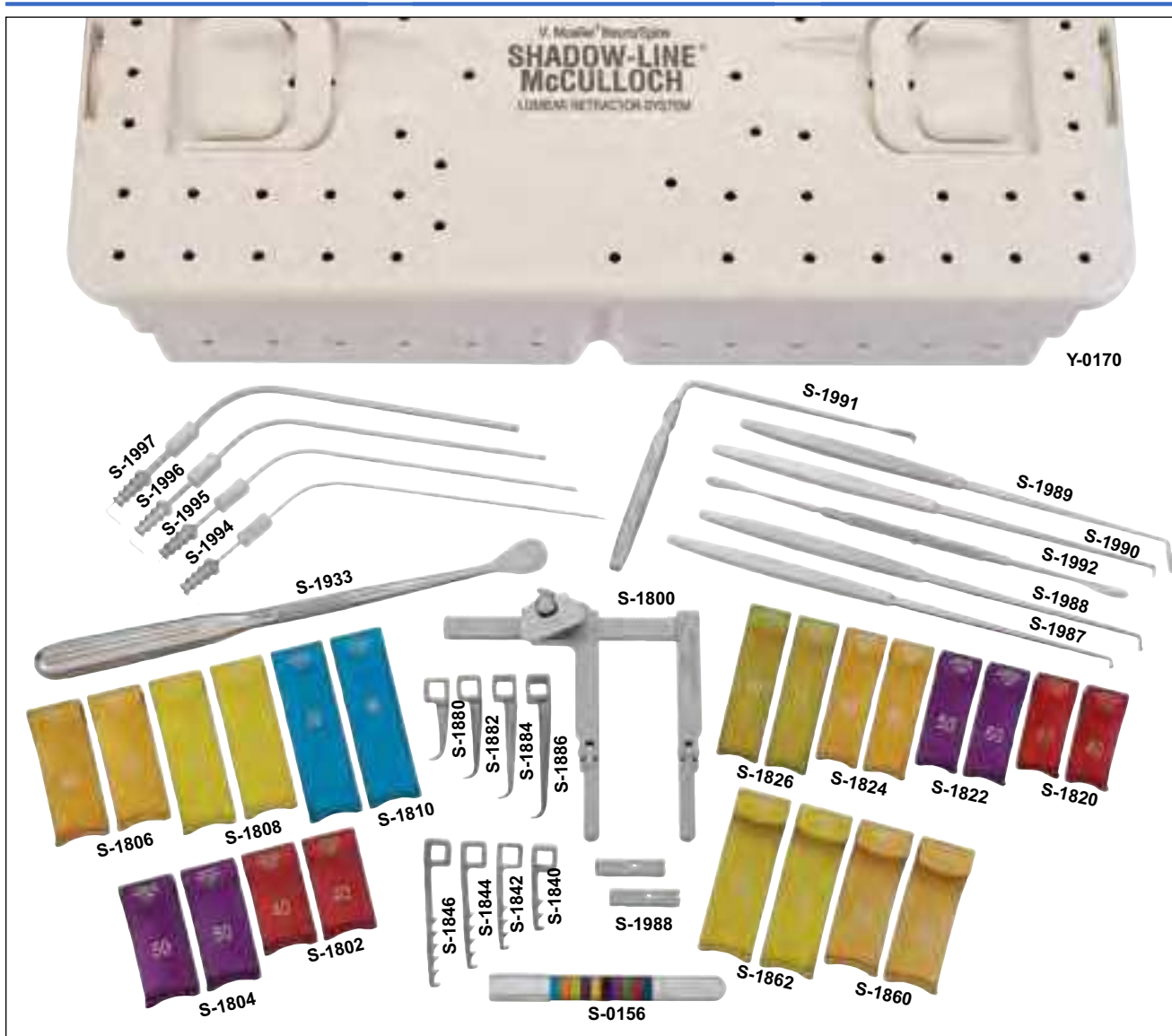

NEURO/SPINE  
AND ORTHOPEDIC

Developed in collaboration with Dr. McCulloch, the Shadow-Line® McCULLOCH Lumbar Retractor is the system of choice for anatomical visualization and operative site accessibility.

- As the first radiolucent retractor system of its class, the Shadow-Line® McCULLOCH Lumbar Retractor System combines a unique mix of blade designs that facilitates both direct visualization and intra-operative imaging of the spinal anatomy.
- Incorporating the well established Shadow-Line® color-coding standard, the Shadow-Line® McCULLOCH Lumbar Retractor System streamlines blade selection to optimize OR time efficiency.
- The blade attachment design also allows full interchangeability with existing McCULLOCH system components.

**SHADOW-LINE® McCULLOCH Lumbar Retractor Set**

Set includes the following:

◆ (KO10013)

Cat. No.	Description	Set Quantity
S-1989	Foraminal probe. Tip length 18mm. Overall length 9-1/2in (24.1cm).	1 each
S-1990	Angled manipulation hok. Tip 5mm wide. Overall length 9-1/2in (24.1cm).	1 each
S-1991	Nerve root retractor. Blade width 6mm. Shaft length 5in (12.7cm).	1 each
S-1992	Double-ended blunt elevator. Blade width 5.6mm. Working length 9in (22.9cm).	1 each
S-1993	COBB-type elevator. Semi-sharp blade 19mm wide. Overall length 10-1/2in (26.7cm).	1 each
S-1994	Suction tube. Working length 5in (12.7cm). 5Fr.	1 each
S-1995	Suction tube. Working length 5in (12.7cm). 7Fr.	1 each
S-1996	Suction tube. Working length 5in (12.7cm). 9Fr.	1 each
S-1997	Suction tube. Working length 5in (12.7cm). 12Fr.	1 each
S-1987	Ball tip probe. 4mm. Overall length 9-1/2in (24cm).	
S-1988	Ball tip probe. 7mm. Overall length 9-1/2in (24cm).	
Z-0161	SHADOW-LINE® McCULLOCH lumbar retractor basic set.	1 each
SHADOW-LINE® McCULLOCH Foraminal Probe		
Overall length 9-1/2in (24.1cm).		
S-1989	Tip length 18mm.	
SHADOW-LINE® McCULLOCH Angled Manipulation Hook		
Overall length 9-1/2in (24.1cm).		
S-1990	Tip 5mm wide.	
SHADOW-LINE® McCULLOCH Nerve Root Retractor		
Shaft length 5in (12.7cm).		
S-1991	Blade width 6mm.	
SHADOW-LINE® McCULLOCH Double-Ended Blunt Elevator		
Working length 9in (22.9cm).		
S-1992	Blade width 5.6mm.	
SHADOW-LINE® McCULLOCH COBB-Type Elevator		
Overall length 10-1/2in (26.7cm).		
S-1993	Semi-sharp blade 19mm wide.	
SHADOW-LINE® McCULLOCH Extension Bar		
S-1998		
SHADOW-LINE® McCULLOCH Color-Coded Depth Gauge		
Aluminum.		
S-0156	For indications up to 100mm.	
SHADOW-LINE® McCULLOCH Wide Muscle Blades		
Aluminum. Blades 27mm wide.		
S-1802	Blade length 40mm. Red.	
S-1804	Blade length 50mm. Violet.	
S-1806	Blade length 60mm. Gold.	
S-1808	Blade length 70mm. Light green.	
SHADOW-LINE® McCULLOCH Suction Tubes		
Working length 5in (12.7cm).		
S-1994	5Fr.	
S-1995	7Fr.	
S-1996	9Fr.	
S-1997	12Fr.	

**SHADOW-LINE® McCULLOCH Lumbar Retractor Basic Set**

Set includes the following:

KO10014

Cat. No.	Description	Set Quantity
S-1800	Retractor frame.	1 each
S-1998	Extension bar.	2 each
S-0156	Depth gauge. Color-coded.	1 each
Y-0170	Instrument case.	1 each
S-1802	Wide muscle blade. Blade 40mm x 27mm wide. Red.	2 each
S-1804	Wide muscle blade. Blade 50mm x 27mm wide. Violet.	2 each
S-1806	Wide muscle blade. Blade 60mm x 27mm wide. Gold.	2 each
S-1808	Wide muscle blade. Blade 70mm x 27mm wide. Light green.	2 each
S-1820	Narrow muscle blade. Blade 40mm x 20mm wide. Red.	2 each
S-1822	Narrow muscle blade. Blade 50mm x 20mm wide. Violet.	2 each
S-1824	Narrow muscle blade. Blade 60mm x 20mm wide. Gold.	2 each
S-1826	Narrow muscle blade. Blade 70mm x 20mm wide. Light green.	2 each
S-1840	Multiple-toothed hook. Length 30mm.	1 each
S-1842	Multiple-toothed hook. Length 40mm.	1 each
S-1844	Multiple-toothed hook. Length 50mm.	1 each
S-1846	Multiple-toothed hook. Length 60mm.	1 each
S-1860	Offset blade. Blade 60mm x 27mm wide. Gold.	2 each
S-1862	Offset blade. Blade 70mm x 27mm wide. Light green.	2 each
S-1880	Hooks. Length 30mm.	
S-1882	Hooks. Length 40mm.	
S-1884	Hooks. Length 50mm.	
S-1886	Hooks. Length 60mm.	
SHADOW-LINE® McCULLOCH Retractor Frame		
S-1800		
SHADOW-LINE® McCULLOCH Narrow Muscle Blades		
Aluminum. Blades 20mm wide.		
S-1820	Blade length 40mm. Red.	
S-1822	Blade length 50mm. Violet.	
S-1824	Blade length 60mm. Gold.	
S-1826	Blade length 70mm. Light green.	
SHADOW-LINE® McCULLOCH Multiple-Toothed Hooks		
S-1840	Length 30mm.	
S-1842	Length 40mm.	
S-1844	Length 50mm.	
S-1846	Length 60mm.	
SHADOW-LINE® McCULLOCH Offset Blades		
Aluminum. Blades 27mm wide.		
S-1860	Wide. 60mm x 27mm wide. Gold.	
S-1862	Wide. 70mm x 27mm wide. Light green.	
SHADOW-LINE® McCULLOCH Hooks		
S-1880	Length 30mm.	
S-1882	Length 40mm.	
S-1884	Length 50mm.	
S-1886	Length 60mm.	

SHADOW-LINE® McCULLOCH Longitudinal Retractor

(KO10015)  
Double-hinged.



SHADOW-LINE® McCULLOCH Transverse Retractor

(KO10016)  
Double-hinged.



SHADOW-LINE® McCULLOCH Cervical Blades  
Aluminum. Blades 22mm wide.



SHADOW-LINE® McCULLOCH Narrow Muscle Blades  
Aluminum. Blades 20mm wide.



NEURO/SPINE  
AND ORTHOPEDIC

Micro-Teeth	Blunt	Length	Color
S-1710	S-1720	30mm	Silver
S-1711	S-1721	35mm	Blue
(S-1712)	S-1722	40mm	Red
	S-1723	45mm	Green
S-1714	S-1724	50mm	Violet
S-1715	S-1725	55mm	Black
S-1716	S-1726	60mm	Gold
S-1717	S-1727	65mm	Navy
S-1718	S-1728	70mm	Light green

Part No.	Blade Length	Color
S-1820	40mm	Red
(S-1822)	50mm	Violet
S-1824	60mm	Gold
S-1826	70mm	Light green
S-1828	80mm	Turquoise

**SHADOW-LINE® McCULLOCH**  
Wide Muscle Blades  
Aluminum. Blades 27mm wide.



Part No.	Blade Length	Color
S-1802	40mm	Red
(S-1804)	50mm	Violet
S-1806	60mm	Gold
S-1808	70mm	Light green
S-1810	80mm	Turquoise

**SHADOW-LINE® McCULLOCH Offset**  
Retractor Blades  
Aluminum. Blades 27mm wide.

Part No.	Blade	Color
S-1856	Wide. Blade 40 x 27mm wide.	Red
S-1858	Wide. Blade 50 x 27mm wide.	Violet
(S-1860)	Wide. 60mm x 27mm wide.	Gold
S-1862	Wide. 70mm x 27mm wide.	Light green
S-1864	Wide. Blade 80mm x 27mm wide.	Turquoise
S-1866	Wide. Blade 90 x 27mm wide.	Copper
S-1868	Wide. Blade 100 x 27mm wide.	Teal
S-1870	Wide. Blade 120 x 27mm wide.	Silver

**SHADOW-LINE® McCULLOCH Offset**  
Retractor Blades  
Aluminum. Optional accessory (not included with Sets Z-0160 or Z-0161). 1 each.

Part No.	Blade	Color
S-1920	Narrow. 40mm x 20mm wide.	Red
S-1922	Narrow. 50mm x 20mm wide.	Violet
S-1924	Narrow. 60mm x 20mm wide.	Gold
S-1926	Narrow. 70mm x 20mm wide.	Light Green
S-1928	Narrow. 80mm x 20mm wide.	Turquoise
S-1930	Narrow. 90mm x 20mm wide.	Copper
S-1932	Narrow. 100mm x 20mm wide.	Teal
S-1934	Narrow. 120mm x 20mm wide.	Silver



**SHADOW-LINE® McCULLOCH Hooks**

KO10017  
Blade length 20mm.

KO10018  
Blade length 30mm.

(KO10019)  
Blade length 40mm.

KO10020  
Blade length 50mm.

KO10021  
Blade length 60mm.

KO10022  
Blade length 70mm.

KO10023  
Blade length 80mm.

KO10024  
Blade length 90mm.

KO10025  
Blade length 100mm.



**SHADOW-LINE® McCULLOCH Multiple-Tooth Hook Blade**

KO10026  
Blade length 20mm.

(KO10027)  
Blade length 30mm.

KO10028  
Blade length 40mm.

KO10029  
Blade length 50mm.

KO10030  
Blade length 60mm.

KO10031  
Blade length 70mm.

KO10032  
Blade length 80mm.

KO10033  
Blade length 90mm.

KO10034  
Blade length 100mm.





### SHADOW-LINE® McCULLOCH

Hook Probes  
Angled. Overall length  
9-1/2in (24cm).

KO10035  
Tip 2mm wide.

KO10036  
Tip 3mm wide.

### SHADOW-LINE® McCULLOCH

Suction Tubes  
Working length  
5in (12.7cm).

KO10040  
5Fr.

KO10041  
7Fr.

KO10042  
9Fr.

KO10043  
12Fr.

### SHADOW-LINE® McCULLOCH Instrument Case

Part No.	Description
◆(KO10037	Complete case includes base, lower insert, middle insert, upper insert and lid
KO10038	Middle insert
KO10039	Base

### SHADOW-LINE® McCULLOCH Instrument Case Case for the Shadow-Line® offset retractor set.

Part No.	Description
Y-0171	Complete case includes base, lower insert, middle insert, upper insert and lid.
Y-0171-0	Lid
Y-0171-1	Upper insert
Y-0171-3	Lower insert



### V. MUELLER® McCULLOCH Universal Set

◆(KO10044)

Includes the following:

- 1 each NL9701-H Hinged retractor frame
- 1 set NL9702-270 Wide muscle blades
- 1 set NL9702-200 Narrow muscle blades
- 1 set NL9702-130 Hook blades
- 1 set NL9702-050 Cervical blades
- 1 each NL9703-001 Nerve root retractor
- 1 each NL9704 Double-ended blunt elevator
- 1 each NL9707-002 COBB-type elevator
- 1 set NL9708-100 Long suction tubes
- 1 set NL9730 Probes
- 1 each NL5075 Lamina spreader

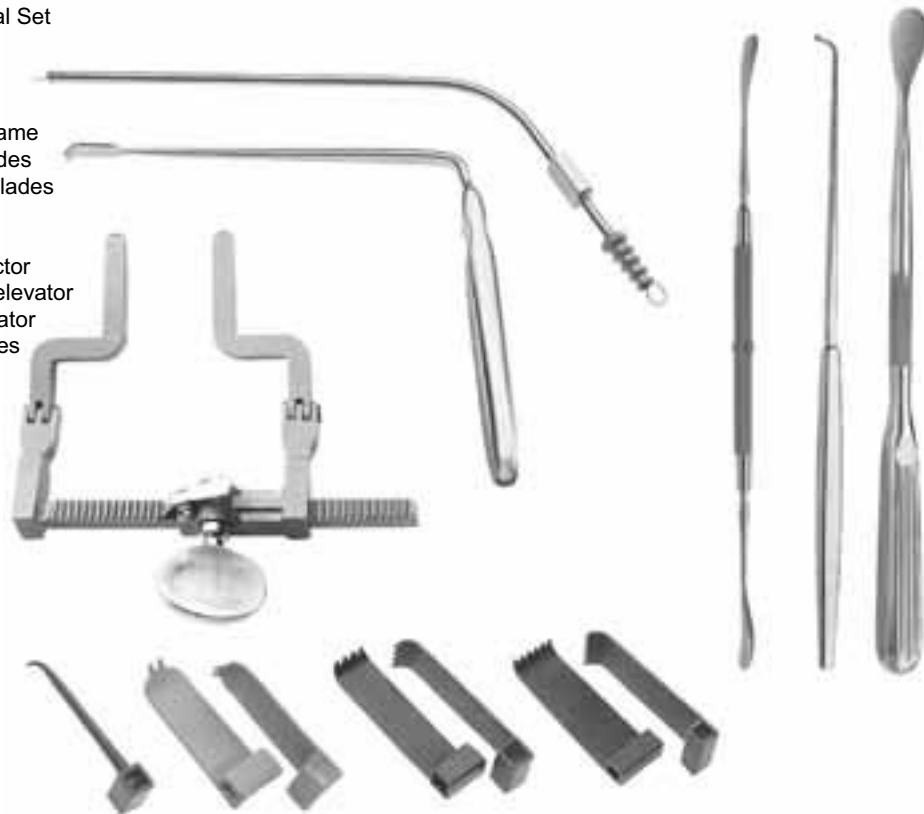

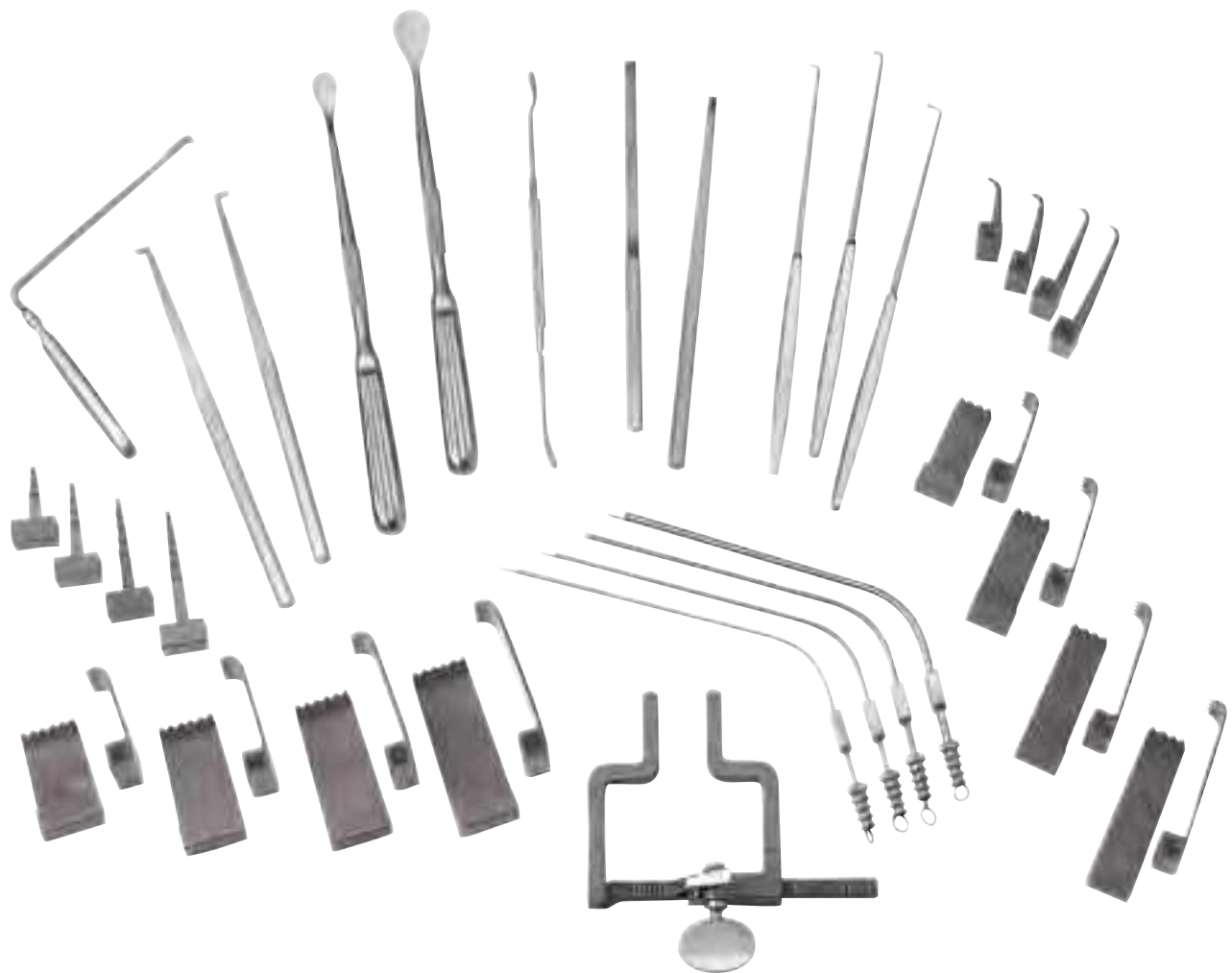

V. MUELLER® McCULLOCH Retractor Set

◆ (KO10045)

Includes the following:

- 1 each NL9701 Retractor frame
- 1 set NL9702 Retractor blades
- 1 each NL9703 Nerve root retractor
- 1 each NL9704 Double-ended blunt elevator
- 1 each NL9705-001 Osteotome, 4mm
- 1 each NL9705-002 Osteotome, 6mm
- 1 each NL9706-001 "Hockey stick" chisel, curved right
- 1 each NL9706-002 "Hockey stick" chisel, curved left
- 1 each NL9707-001 COBB-type elevator, blade 1/2in (1.3cm) wide
- 1 each NL9707-002 COBB-type elevator, blade 3/4in (1.9cm) wide
- 1 set NL9708 Suction tubes
- 1 each NL9709-001 Ball probe, 4mm
- 1 each NL9709-002 Ball probe, 7mm
- 1 each NL9710-005 Manipulation hook.



V. MUELLER® McCULLOCH Retractor Set With Hinged Retractor Frame

McCULLOCH Wide Muscle Blade Set  
Blades 2.7cm wide. Satin finish.

McCULLOCH Narrow Muscle Blade Set  
Blades 2cm wide. Satin finish.

◆ KO10046

Same as NL9700 only includes Hinged Retractor Frame NL9701-H in place of Straight Retractor Frame NL9701.



KO10047

Set. Includes 1 pair each of the following:  
NL9702-116 (3cm)  
NL9702-111 (4cm)  
NL9702-112 (5cm)  
NL9702-113 (6cm)  
NL9702-114 (7cm)  
NL9702-115 (8cm)

KO10048

Set. Includes 1 pair each of the following:  
NL9702-126 (3cm)  
NL9702-121 (4cm)  
NL9702-122 (5cm)  
NL9702-123 (6cm)  
NL9702-124 (7cm)  
NL9702-125 (8cm)

McCULLOCH Hook Set  
Satin finish.

McCULLOCH Cervical Blade Set  
Reverse bend with 2 teeth. Blades 2cm wide. Satin finish.

Due to changing surgical trends, some products described in this catalog may be discontinued. Your V. Mueller sales representative may be able to suggest a suitable substitute if one is available.



KO10049

Set. Includes 1 each of the following:  
S-1878 (2cm)  
S-1880 (3cm)  
S-1882 (4cm)  
S-1884 (5cm)  
S-1886 (6cm)  
S-1888 (7cm)

KO10050

Set. Includes 1 pair each of the following:  
NL9702-155 (5cm)  
NL9702-156 (6cm)  
NL9702-157 (7cm)

NEURO/SPINE  
AND ORTHOPEDIC

McCULLOCH Rigid Retractor Frame  
Satin finish.



◆ KO10051

NL9701-H  
Hinged frame.

McCULLOCH Retractor Blade Set  
Satin finish.



◆ KO10052

Includes 1 set each of the following:  
 NL9702-110 Wide muscle blades  
 NL9702-120 Narrow muscle blades  
 NL9702-130 Hook blades  
 NL9702-140 Multi-toothed blades

McCULLOCH Wide Muscle  
Blade Set  
Blades 2.7cm wide. Satin finish.



◆ KO10053

Set. Includes 1 pair each of the following:  
 NL9702-111 (4cm)  
 NL9702-112 (5cm)  
 NL9702-113 (6cm)  
 NL9702-114 (7cm)

McCULLOCH Narrow Muscle  
Blade Set  
Blades 2cm wide. Satin finish.



◆ KO10054

Set. Includes 1 pair each of the following:  
 NL9702-121 (4cm)  
 NL9702-122 (5cm)  
 NL9702-123 (6cm)  
 NL9702-124 (7cm)

McCULLOCH Wide Muscle Blade Set  
Blades 2.7cm wide. Satin finish.



Blade length 4cm. Pair.

- ◆ KO10055  
Blade length 5cm. Pair.
- ◆ KO10056  
Blade length 6cm. Pair.
- ◆ KO10057  
Blade length 7cm. Pair.
- KO10058  
Blade length 3cm. Pair.

◆ KO10059

Blade length 8cm. Pair.

McCULLOCH Narrow Muscle  
Blade Set  
Blades 2cm wide. Satin finish.



◆ KO10060  
Blade length 4cm. Pair.

◆ KO10061  
Blade length 5cm. Pair.

◆ KO10062  
Blade length 6cm. Pair.

◆ KO10063  
Blade length 7cm. Pair.

KO10064  
Blade length 3cm. Pair.

KO10065  
Blade length 8cm. Pair.

**McCULLOCH Hook Blades**  
Satin finish.

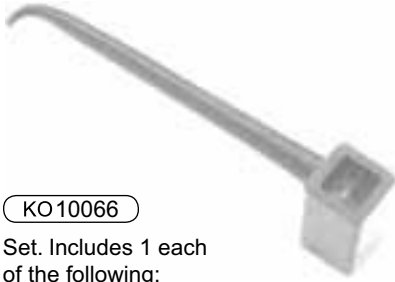

KO10066

Set. Includes 1 each of the following:  
S-1880 (3cm)  
S-1882 (4cm)  
S-1884 (5cm)  
S-1886 (6cm)

**McCULLOCH Multiple-Tooth Blade Set**  
Satin finish.



KO10067

Set. Includes 1 each of the following:  
S-1840 (3cm)  
S-1842 (4cm)  
S-1844 (5cm)  
S-1846 (6cm)

KO10068

Set. Includes 1 each of the following:  
S-1878 (2cm)  
S-1840 (3cm)  
S-1842 (4cm)  
S-1844 (5cm)  
S-1846 (6cm)  
S-1848 (7cm)

**McCULLOCH Cervical Blades**  
Reverse bend with 2 teeth. Blades 2cm wide.  
Satin finish.



KO10069

Blade length 5cm. Pair.

KO10070

Blade length 6cm. Pair.

KO10071

Blade length 7cm. Pair.

To learn how the IMPRESS system can help improve process performance, reduce immediate-use steam sterilization, decrease case delays, and improve patient care by monitoring instrument flow within your facility, contact your V. Mueller sales representative.

**McCULLOCH Probes**  
Overall length 9-1/2in (24.1cm).

KO1072

Set. Includes 1 each of the following:

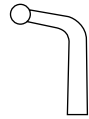

KO10073

Angled ball tipped probe, 8mm from shaft to ball.



KO10075

Angled manipulation hook. 2mm tip.



KO10074

Angled manipulation hook. 3mm tip.



KO10076

Angled manipulation hook. 5mm tip.

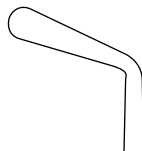

KO10077

Foraminal probe. 18mm tip.

McCULLOCH Angled Ball-Tipped Probes  
Overall length 9-1/2in (24.1cm).

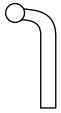

KO10078  
Tip length 4mm.

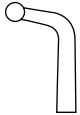

**KO10079**  
Tip length 7mm.



McCULLOCH Suction Tubes  
Working length 5in (12.7cm).

KO10080  
Set. Includes 1 each  
of the following:

Cat. No.	Size
KO10081	(5Fr.)
KO10082	(7Fr.)
KO10083	(9Fr.)
<b>KO10084</b>	(12Fr.)

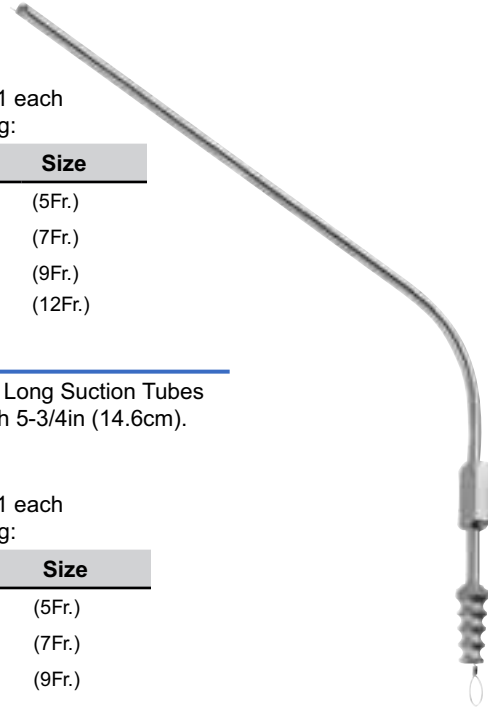

McCULLOCH Long Suction Tubes  
Working length 5-3/4in (14.6cm).

KO10085  
Set. Includes 1 each  
of the following:

Cat. No.	Size
KO10086	(5Fr.)
KO10087	(7Fr.)
KO10088	(9Fr.)
KO10089	(12Fr.)

McCULLOCH Double-Ended  
Blunt Elevator  
Blades 5.6mm wide.

**KO10090**  
Working length 9in (22.9cm).



Osteotomes  
Overall length  
8-1/2in (21.6cm).

**KO10091**  
4mm.  
  
KO10092  
6mm.



McCULLOCH "Hockey Stick"  
Chisels  
5mm. Overall length  
8-1/2in (21.6cm).

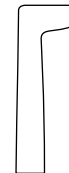

**KO10093**  
Curved right.  
  
KO10094  
Curved left.





Surgical Instruments - Dental Instruments - Orthopedic Implants

**Lala Zar Chowk, Muhammad PURA,  
SIALKOT 51310 PAKISTAN**

Tel: +92 300 864132

E-mail: [info@kahluortho.com](mailto:info@kahluortho.com)

Web: [www.kahluortho.com](http://www.kahluortho.com)